

# 3174

# HIOKI

# 3174-01

## Instruction Manual

# AC AUTOMATIC INSULATION/WITHSTANDING HiTESTER



**Be sure to read this manual before using the instrument.**

▶ p.2



**When using the instrument for the first time**

Names and Functions of Parts ▶ p.9

Testing Arrangements ▶ p.17



**Troubleshooting**

Maintenance and Service ▶ p.197

Error Indication ▶ p.200

## EN

May 2019 Revised edition 8  
3174A981-08 19-05H





# Contents

Introduction.....	1
Confirming Package Contents.....	1
Safety Information .....	2
Operating Precautions.....	4
<b>Chapter 1</b>	
<b>Overview</b> .....	<b>7</b>
1.1 Product Overview .....	7
1.2 Features .....	7
1.3 Names and Functions of Parts .....	9
1.3.1 3174 (3174-01) .....	9
1.3.2 Display .....	12
1.3.3 Model 9615 H.V.Test Lead .....	13
1.4 External Dimensions .....	14
1.5 Testing Process .....	15
<b>Chapter 2</b>	
<b>Testing Arrangements</b> .....	<b>17</b>
2.1 Arrangements Work Flow .....	17
2.2 Connecting the Protective Conductor Terminal .....	18
2.3 Connecting the Power Cord .....	19
2.4 Connecting the Test Lead .....	20
2.4.1 When using the Contact Check Function .....	21
2.4.2 When not using the Contact Check Function .....	23
2.5 Turning the Power On and Off .....	24
2.6 Pre-test Check .....	26
<b>Chapter 3</b>	
<b>Withstand-Voltage Test</b> .....	<b>29</b>
3.1 Setting the Test-Conditions .....	31
3.1.1 Setting the Test-Voltage Value .....	32
3.1.2 Setting the Upper (Lower) Limit Value .....	33
3.1.3 Setting the Test Time Timer .....	34

3.1.4	Setting the Ramp-up (Ramp-down) Time Timer .....	35
3.1.5	Setting the Test-Frequency .....	36
3.1.6	Setting the Initial voltage for ramp-up .....	37
3.1.7	Setting the Confirmation Voltage used for upper and lower-limits for Contact Check .....	38
3.2	Starting a Test .....	40
3.3	Terminate the Test .....	42
3.4	Displaying the Test Result .....	44
3.4.1	"PASS" Determination .....	45
3.4.2	"FAIL" Determination .....	46

## Chapter 4

### Insulation-Resistance Test 47

4.1	Setting the Test Conditions .....	49
4.1.1	Setting the Test-Voltage Value .....	50
4.1.2	Setting the Upper (Lower) Limit Value .....	51
4.1.3	Setting the Test Time Timer .....	53
4.1.4	Setting the Delay Time .....	54
4.1.5	Setting the Confirmation Voltage used for upper and lower-limits for Contact Check .....	55
4.2	Starting a Test .....	57
4.3	Terminate the Test .....	59
4.4	Displaying the Test Result .....	61
4.4.1	"PASS" Determination .....	62
4.4.2	"FAIL" Determination .....	63
4.4.3	Influence of capacity on the test result (reference data) .....	65

## Chapter 5

### Automatic Test 69

5.1	Setting the Test Conditions .....	70
5.2	Starting a Test .....	71
5.3	Terminate the Test .....	73
5.4	Displaying the Test Result .....	75
5.4.1	"PASS" Determination .....	76
5.4.2	"FAIL" Determination .....	78

---

<b>Chapter 6</b>	
<b>Useful Functions</b>	<b>79</b>
6.1	Functions for carrying out the tests safely ..... 79
6.1.1	Key-lock Function ..... 79
6.1.2	Momentary Out ..... 80
6.1.3	Double Action ..... 81
6.1.4	START Protection ..... 82
6.1.5	Output-Voltage Restricting ..... 83
6.2	Display Hold (Hold Function) ..... 84
6.2.1	PASS Hold ..... 85
6.2.2	FAIL Hold ..... 86
6.2.3	STOP Hold ..... 87
6.3	Evaluate even for forced termination of test ..... 88
6.4	Continue testing even after FAIL result is shown (Continuous Test Mode, Only Withstanding-Test) ..... 89
6.5	Limiting the FAIL Hold Cancellation (FAIL mode) ..... 90
6.6	Changing the Output Voltage during the withstanding test ..... 91
6.7	Insulation-Resistance Test Termination Mode ..... 92
6.8	Auto-range for insulation-resistance test ..... 95
6.9	Status Out ..... 96
<b>Chapter 7</b>	
<b>Saving / Loading test conditions</b>	<b>99</b>
7.1	Saving the Test Conditions ..... 99
7.2	Loading the Test Conditions ..... 102
<b>Chapter 8</b>	
<b>External Interface</b>	<b>103</b>
8.1	Outline of External I/O ..... 103
8.1.1	Explanations of signal line ..... 104
8.1.2	Connecting the External I/O connector ..... 106
8.2	Example of Signal Connection ..... 107
8.3	Inter-lock Function ..... 111
8.4	TEST-Signal Output ..... 113
8.5	Selecting test mode and saved test condition ..... 114
8.6	Timing Chart ..... 115
8.7	Adjusting the Buzzer sound ..... 119



<b>Chapter 9</b>	
<b>RS-232C/GP-IB Interface</b>	<b>121</b>
9.1	Specifications ..... 123
9.2	Connection and Setting Procedures ..... 124
9.2.1	Connecting the Connector ..... 124
9.2.2	Setting the Communication Conditions ..... 126
9.3	Communication Methods ..... 128
9.3.1	Message Format ..... 129
9.3.2	Output Queue and Input Buffer ..... 132
9.3.3	Status Byte Register ..... 133
9.3.4	Event Registers ..... 135
9.3.5	Initialization Items ..... 138
9.3.6	Local Function ..... 138
9.3.7	Command Reference List ..... 139
9.4	Message Reference ..... 143
9.4.1	Common Command ..... 144
9.4.2	Device-Specific Commands ..... 149
9.4.3	Transmission and response formats ..... 183
9.4.4	Sample program Flowchart ..... 184
9.5	Interface Command "START" ..... 188
<b>Chapter 10</b>	
<b>Specifications</b>	<b>189</b>
10.1	Basic Specifications ..... 189
10.2	General Specifications ..... 195
10.3	H.V.Test Lead (Accessory) Specifications ..... 196
<b>Chapter 11</b>	
<b>Maintenance and Service</b>	<b>197</b>
11.1	Troubleshooting ..... 197
11.2	Cleaning ..... 199
11.3	Error Indication ..... 200
11.4	System Reset ..... 201
<b>Appendix</b>	<b>A 1</b>
Appendix1	Remote Control Box..... A 1
Appendix2	List of Optional Functions ..... A 4
<b>Index</b>	<b>Index i</b>

## Introduction

Thank you for purchasing the HIOKI "Model 3174, 3174-01 AC Automatic Insulation/Withstanding HiTester." To obtain maximum performance from the instrument, please read this manual first, and keep it handy for future reference.

## Confirming Package Contents

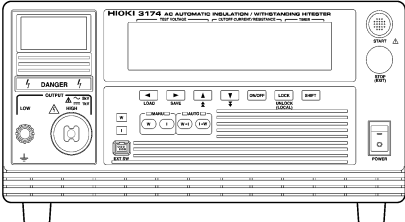
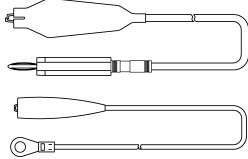
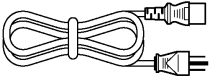
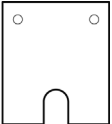
- When you receive the instrument, inspect it carefully to ensure that no damage occurred during shipping. In particular, check the accessories, panel switches, and connectors. If damage is evident, or if it fails to operate according to the specifications, contact your dealer or Hioki representative.
- When transporting the instrument, use the original packing materials in which it was shipped, and pack in a double carton. Damage occurring during transportation is not covered by warranty.

 <p>Model 3174 (-01) AC Automatic Insulation/Withstanding HiTester ..... 1</p>	 <p>Model 9615 H.V. Test Lead ..... (HIGH/ LOW, 1 each)</p>
 <p>Power Cord..... 1</p>	 <p>Slip Prevention Plate ..... 1</p>
 <p><b>Instruction Manual (This document). 1</b></p>	

\* The 3174-01 AC Automatic Insulation/Withstanding HiTester can be used with GP-IB.

- Options**
- 9613 Remote Control Box (Single)
  - 9614 Remote Control Box (Dual)
  - 9615 H.V. Test Lead
  - 9267 Safety Test Data Management Software
  - 9637 RS-232C Cable (1.8 m, 9-pin to 9-pin)
  - 9638 RS-232C Cable (1.8 m, 9-pin to 25-pin)
  - 9151-02 GP-IB Connector Cable (2 m)









## Safety Information







This instrument is designed to comply with IEC 61010 Safety Standards, and has been thoroughly tested for safety prior to shipment. However, mishandling during use could result in injury or death, as well as damage to the instrument. Using this instrument in ways other than those specified in this manual may damage functions which guarantees the safety of this instrument. Be certain that you understand the instructions and precautions in the manual before use. We disclaim any responsibility for accidents or injuries not resulting directly from instrument defects.

### Safety Symbols

This manual contains information and warnings essential for safe operation of the instrument and for maintaining it in safe operating condition. Before using it, be sure to carefully read the following safety precautions.



	Indicates cautions and hazards. Refer to the "Usage Notes" section of the instruction manual.
	Indicates that dangerous voltage may be present at this terminal.
	Indicates DC (Direct Current).
	Indicates AC (Alternating Current).
	Indicates a grounding terminal.
	Indicates a protective conductor terminal.
	Indicates the ON side of the power switch.
	Indicates the OFF side of the power switch.

The following symbols in this manual indicate the relative importance of cautions and warnings.

	Indicates an imminently hazardous situation that will result in death or serious injury to the operator.
	Indicates a potentially hazardous situation that may result in death or serious injury to the operator.
	Indicates a potentially hazardous situation that may result in minor or moderate injury to the operator or damage to the instrument or malfunction.
	Indicates advisory items related to performance or correct operation of the instrument.



## Other symbols

	This symbol indicates that the product conforms to regulations set out by the EU Directive.
	Indicates a prohibited action.
( p. )	Indicates the location of reference information.
	Indicates quick references for operation and remedies for trouble-shooting.
*	Indicates that descriptive information is provided below.

## Accuracy

We define measurement tolerances in terms of f.s. (full scale), rdg. (reading) and dgt. (digit) values, with the following meanings:

f.s. (maximum display value or scale length)

The maximum displayable value or scale length. This is usually the name of the currently selected range.

rdg. (reading or displayed value)

The value currently being measured and indicated on the measuring instrument.

dgt. (resolution)

The smallest displayable unit on a digital measuring instrument, i.e., the input value that causes the digital display to show a "1" as the least-significant digit.

## Measurement categories

To ensure safe operation of measurement instrument, IEC 61010 establishes safety standards for various electrical environments, categorized as CAT II to CAT IV, and called measurement categories.

CAT II:	Primary electrical circuits in equipment connected to an AC electrical outlet by a power cord (portable tools, household appliances, etc.) CAT II covers directly measuring electrical outlet receptacles.
CAT III:	Primary electrical circuits of heavy equipment (fixed installations) connected directly to the distribution panel, and feeders from the distribution panel to outlets.
CAT IV:	The circuit from the service drop to the service entrance, and to the power meter and primary overcurrent protection instrument (distribution panel).

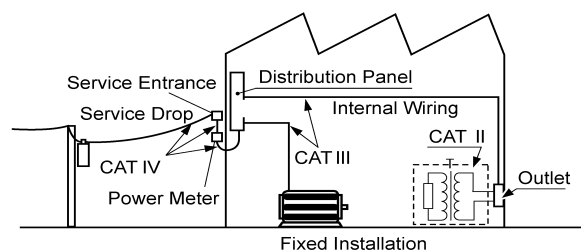

Using a measurement instrument in an environment designated with a higher-numbered category than that for which the instrument is rated could result in a severe accident, and must be carefully avoided.

Use of a measurement instrument that is not CAT-rated in CAT II to CAT IV measurement applications could result in a severe accident, and must be carefully avoided.

## Operating Precautions

### Instrument Installation

Operating temperature and humidity:

0°C to 40°C at 80% RH or less (no condensation)

Temperature and humidity range for guaranteed accuracy:

23°C±5°C, 80% RH or less (no condensation)

after 10 minutes minimum warm-up

**Avoid the following locations that could cause an accident or damage to the instrument.**



Exposed to direct sunlight  
Exposed to high temperature



In the presence of corrosive or explosive gases



Exposed to liquids  
Exposed to high humidity or condensation



Exposed to strong electromagnetic fields  
Near electromagnetic radiators



Exposed to high levels of particulate dust



Subject to vibration

### Installation

- The instrument should be operated only with the bottom side downwards.

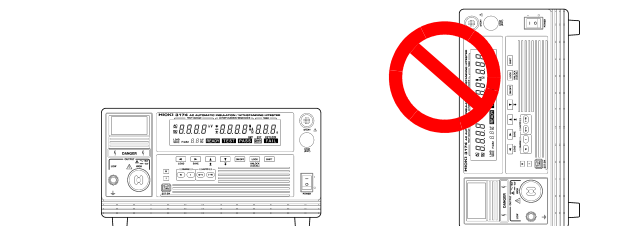

- Vents must not be obstructed.

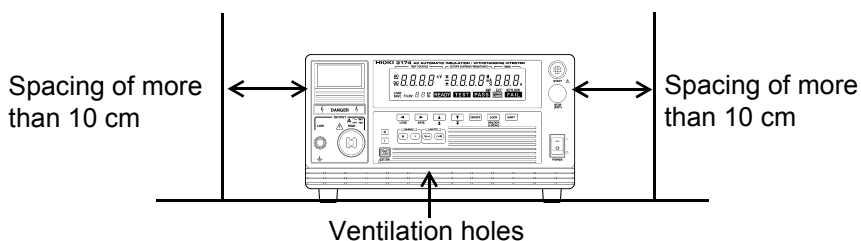

## Before Use

Before using the instrument the first time, verify that it operates normally to ensure that no damage occurred during storage or shipping. If you find any damage, contact your dealer or Hioki representative.

### **DANGER**

Before using the instrument, make sure that the insulation on the test leads is undamaged and that no bare conductors are improperly exposed. Using the instrument in such conditions could cause an electric shock, so contact your dealer or Hioki representative for replacements. (Model 9615 H.V. Test Lead)

### **WARNING**

To avoid electric shock when measuring live lines, wear appropriate protective gear, such as insulated rubber gloves, boots and a safety helmet.

## Handling the Instrument

### **DANGER**

- To avoid electric shock, do not remove the instrument's case. The internal components of the instrument carry high voltages and may become very hot during operation.
- To avoid damage to the instrument, protect it from physical shock when transporting and handling. Be especially careful to avoid physical shock from dropping.

### NOTE

This instrument may cause interference if used in residential areas. Such use must be avoided unless the user takes special measures to reduce electromagnetic emissions to prevent interference to the reception of radio and television broadcasts.

## Handling the test leads

### **WARNING**

To avoid electric shock, do not exceed the lower of the ratings shown on the instrument and test leads.

### **CAUTION**

- For safety reasons, when taking measurements, only use the 9615 H.V. Test Lead provided with the instrument.
- To avoid breaking the test leads, do not bend or pull them.

**Safety Precautions during Testing**

To prevent electric shock, when the **DANGER** lamp is lit or during the test, never touch the voltage output terminals, test lead, or the tested object.

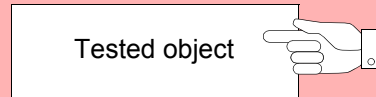
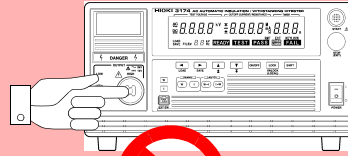
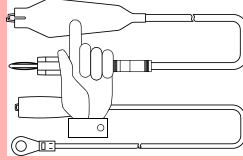

# Overview

# Chapter 1

1

## 1.1 Product Overview

Inaccuracies in measurements have been noted to occur during the withstand-voltage and insulation-resistance tests because of variations in the test voltage caused by fluctuations in the voltage supply, breaking of the test leads and improper connection.

Model 3174, 3174-01 AC Automatic Insulation/Withstanding HiTester is an affordable insulation/withstanding testing instrument equipped with stable voltage supply and contact check functions to prevent a decrease in testing reliability caused by these factors.

In addition, to improve the efficiency of the testing process on the production line, it allows testing settings to be retrieved from both RS-232C (GP-IB) as well as EXT I/O.

Front Panel

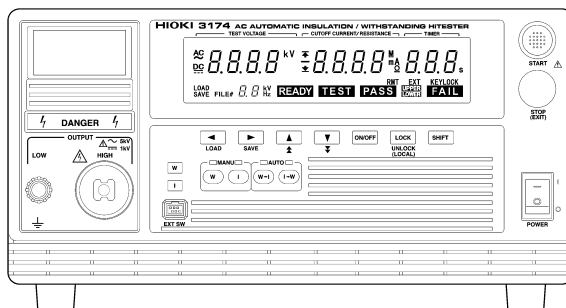

Rear Panel

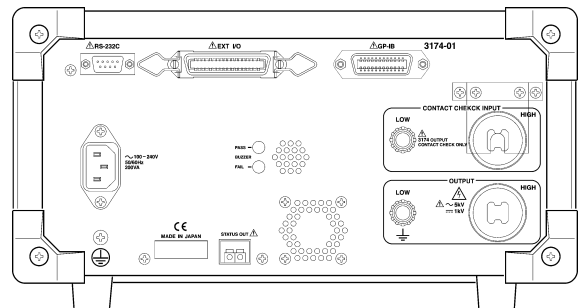

## 1.2 Features

### ◆ Carry out standards-based tests with simple operations

Once test conditions have been pre-set beforehand, withstanding and insulation-resistance tests which meet industrial standards can be carried out with just the simple push of a button. Functions such as PASS-FAIL evaluation based on upper-limit and lower-limit test values, testing time timer, ramp-up/ramp-down time timer to control voltage fluctuations ensure accurate test results are obtained.

### ◆ Saving and loading test conditions

Once test conditions required for the various industrial standards and device to be tested have been saved, tests can be carried out smoothly by just switching to the required test conditions. Up to 8 conditions can be saved for the withstanding and insulation-resistance tests respectively. In addition, test conditions for the last test are automatically retrieved when the power is switched on.

- ◆ **Automatically carry out consecutive withstanding and insulation-resistance tests**

Withstanding and insulation-resistance tests can be carried out consecutively when the respective test conditions have been pre-set. Pressing the **W→I** key will automatically run the withstanding test followed by the insulation-resistance test, pressing the **I→W** key will automatically run the insulation-resistance test followed by the withstanding test.
  - ◆ **Contact check function to increase testing reliability**

With the contact check function, the reliability of tests carried out improves without the need to increase testing time (Another set of the 9615 H.V. Test Lead is necessary)
  - ◆ **Real execution value shown**

By showing the real execution value, tests faithful to industrial standards are carried out.
  - ◆ **Cutting out influence from supply voltage fluctuations**

By using PWM switching power supply, the desired voltage supply can be set so even if the supply voltage fluctuates within  $\pm 10\%$  of the preset value, the test voltage will not be affected. This improves the reliability of the test results.
  - ◆ **Continuation of testing even after test failure makes analysis of sample possible (Test Continuation status)**

Under normal conditions, testing immediately stops when the test fails, making it impossible to determine whether the cause is because of a short circuit or a value exceeding the threshold value. The Test Continuation Status allows the test to continue even after a FAIL result is obtained, thus making it possible to analyze the problem.
  - ◆ **EXT I/O in standard package**

This instrument is equipped with EXT I/O as a standard package. This enables signal transmissions from EXT I/O, start and stop controls of tests and retrievals of saved test conditions.
  - ◆ **RS-232C (Standard Package)/GP-IB Interface (Standard Package for 3174-01 only)**

This instrument is equipped with RS-232C as a standard package and the 3174-01 is also equipped with GP-IB as a standard package. By connecting to a computer, they allow for auto testing to be carried out and test results to be read.
  - ◆ **Easy-to-see big screen**

Big-sized fluorescent display tubes are used for the display, allowing test conditions and test results to be confirmed easily.
  - ◆ **Remote Control Box for safer test administrations (optional)**

When the optional Remote Control Box is connected to the instrument, test start or test stop functions can be performed without touching the instrument, thus making test administrations safer. The 9613 Remote Control Box (Single), 9614 Remote Control Box (Dual) are available.
-

# 1.3 Names and Functions of Parts

## 1.3.1 3174 (3174-01)

Explanations on names and parts of instrument.

### Front Panel

#### DANGER lamp

Light blinks to warn of voltage supply.



To prevent electric shock, when the **DANGER** lamp is lit, never touch the voltage output terminals, test lead, or the tested object.



Please carry out the test regularly on the instrument by following the test procedures in "2.6 Pre-test Check" (p. 26).  
See "6.1.3 Double Action" (p. 81)

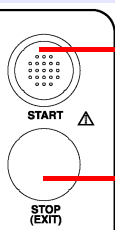

#### START Key

Start a test.  
(Functions only when the **READY** lamp is lit.)

#### STOP Key

Terminate a test.

Display  
(p. 12)

Operation Keys  
(p. 10)

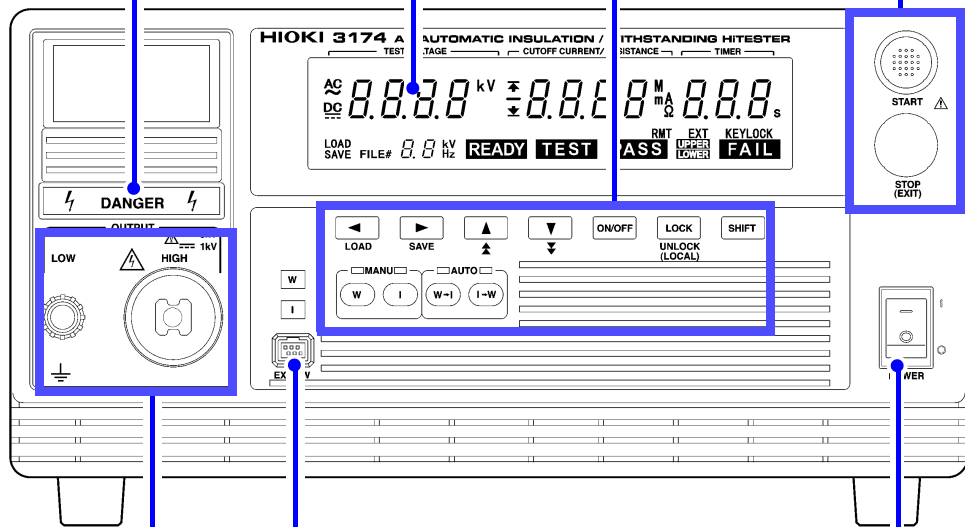

#### Connection terminal for remote control

Connect the remote control box (optional)

#### POWER Switch

Turns the instrument on and off.

- | : Power on
- : Power off

#### HIGH Voltage output terminal

The HIGH terminal is a high-voltage terminal for voltage outputs.

#### LOW Voltage output terminal

The LOW terminal is a low-voltage terminal for voltage outputs. It has the same electric potential as the unit body.

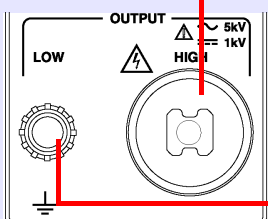

(The diagram shows a 3174 AC Automatic Insulation/Withstanding HiTester.)

### Operation Keys

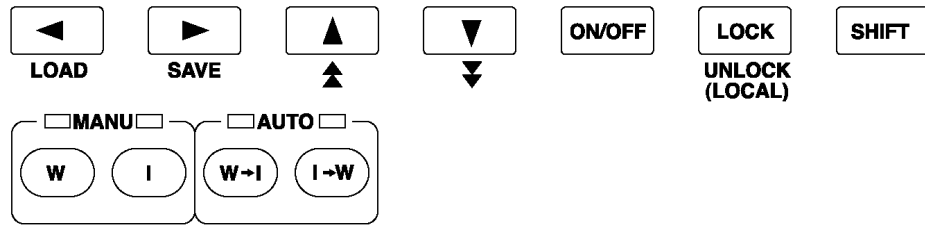

	Moves the flashing cursor to the left.
	Moves the flashing cursor to the right.
	Raise the selected value with the flashing cursor.
	Lower the selected value with the flashing cursor.
	Change the ON/OFF for the selected setting with the flashing cursor. If turned off, the set value is not used in testing. <ul style="list-style-type: none"> <li>The following item can't perform the switching on/off: <ul style="list-style-type: none"> <li>Withstand-voltage test: <ul style="list-style-type: none"> <li>Test-voltage value, Test-voltage frequency, Upper-limit test value</li> </ul> </li> <li>Insulation-resistance test: <ul style="list-style-type: none"> <li>Test-voltage value, Lower-limit test value</li> </ul> </li> </ul> </li> </ul>
	Used to lock the keys. Only the following keys are available during Key Lock. (p. 79) <ul style="list-style-type: none"> <li><b>UNLOCK</b> key (<b>LOCK</b> + <b>SHIFT</b> key)</li> <li><b>START</b> key</li> <li><b>STOP</b> key</li> </ul> <ul style="list-style-type: none"> <li>In the remote state, this key functions as a <b>LOCAL</b> key. It cancels the remote state.</li> </ul>
	Used in combination with other keys. <ul style="list-style-type: none"> <li><b>SHIFT</b> +  key Displaying the loading screen.(p. 102)</li> <li><b>SHIFT</b> +  key Displaying the saving screen.(p. 99)</li> <li><b>SHIFT</b> + <b>LOCK</b> key Cancels the key lock. When GP-IB is used for communication, go to LOCAL state.</li> <li><b>SHIFT</b> +  /  key Changing the increment size of setting values.</li> </ul>
	Performs withstand-voltage tests and settings. "Chapter 3 Withstand- Voltage Test" (p. 29)
	Performs insulation-resistance tests and settings. "Chapter 4 Insulation- Resistance Test" (p. 47)
	Tests for withstand-voltage, then insulation-resistance. "Chapter 5 Automatic Test" (p. 69)
	Tests for insulation-resistance, then withstand-voltage. "Chapter 5 Automatic Test" (p. 69)



## Rear Panel

1

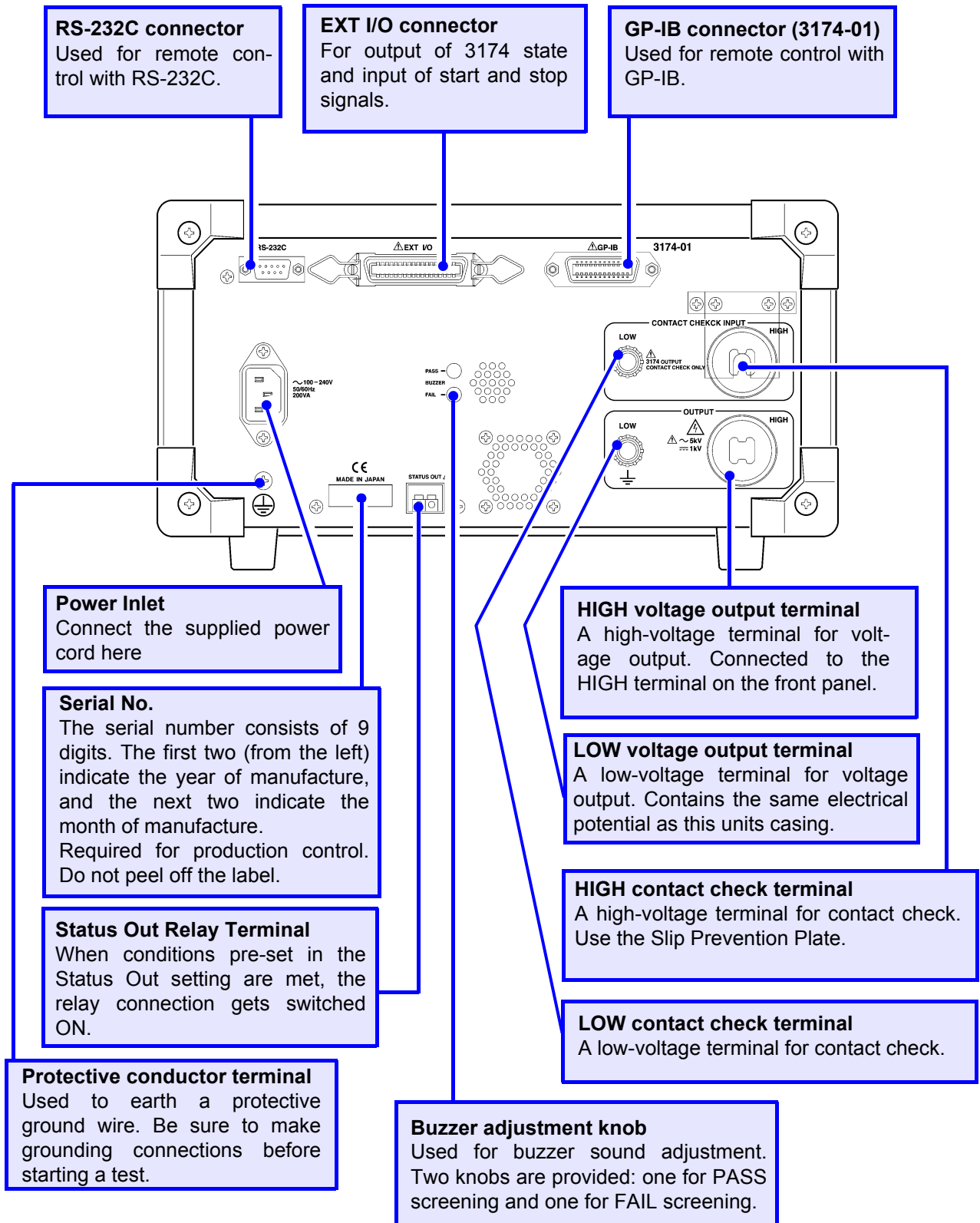

The diagram shows a 3174-01 (with GP-IB) AC Automatic Insulation/Withstanding HiTester.

### 1.3.2 Display

Test setting conditions and current status of the instrument are shown in the panel on front of the instrument.

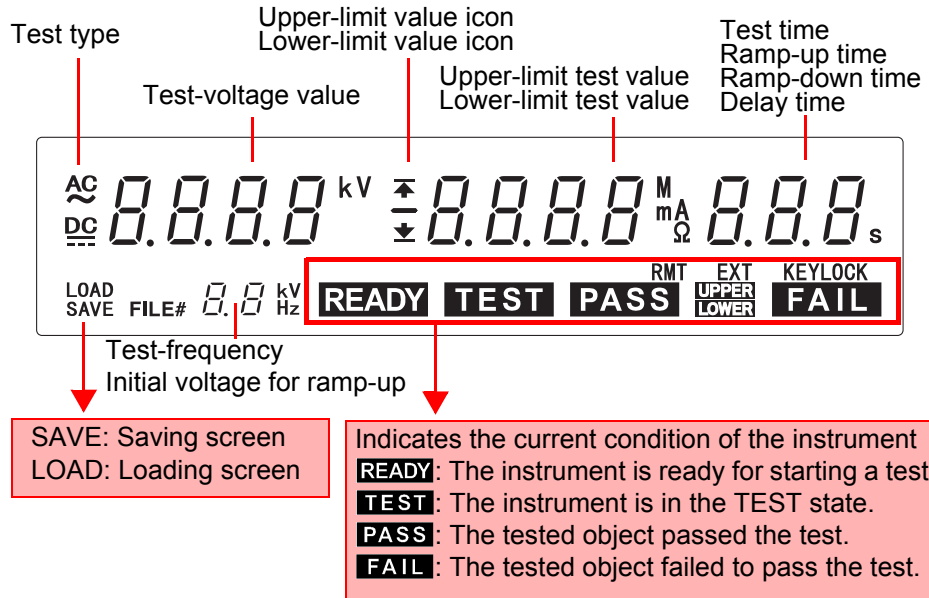

Test type	<p>“AC” lights up during withstanding testing.</p> <p>“DC” lights up during insulation-resistance testing.</p>
Test-voltage value	<p>During testing and READY: Monitors and indicates the voltage of the output terminal.</p> <p>During voltage setting: Indicates the each item set. (output voltage, Contact Check upper (lower)-limit voltage)</p> <p>Reverse current cannot be detected because monitor shows voltage and residual voltage.</p>
Upper-limit value icon	Lights up when indicating the upper-limit test value.
Lower-limit value icon	Lights up when indicating the lower-limit test value.
Upper-limit test value Lower-limit test value	Indicates the upper-limit test value when the upper-limit value icon lights up and indicates the lower-limit test value when the lower-limit value icon lights up. Also indicates the Contact Check upper-limit voltage when [Hi] is shown in Test Frequency and Initial Ramp-up Voltage, and indicates the Contact Check lower-limit voltage with [Lo].
Test time Ramp-up time Ramp-down time Delay time	<p>Indicates testing time.</p> <p>Indicates the ramp-up time when [UP] is shown in Test Frequency and Initial Ramp-up Voltage, and indicates the ramp-down time together with [dn].</p> <p>Indicates the delay time together with [dL] during insulation-resistance testing.</p>
Test-frequency Initial voltage for ramp-up	Indicates Test Frequency (50 Hz/60 Hz) when [Hz] is shown. Indicates the Initial Voltage (proportion to Testing Voltage) when Ramp-up Timer is being used within the range of 0 to 1.0.

1.3.3 Model 9615 H.V. Test Lead

1

Explanations on names and parts of Test Lead.



To prevent electric shock, when the **DANGER** lamp is lit or during the test, never touch the voltage output terminals, test lead, or the tested object. There is no insulation/withstand-voltage on the Alligator clip vinyl covering.

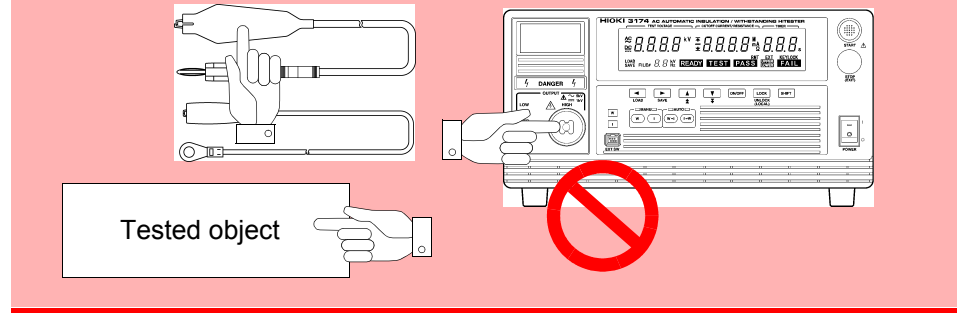

9615 H.V. Test Lead

**Alligator Clip**

Connect to a test point on the tested object.

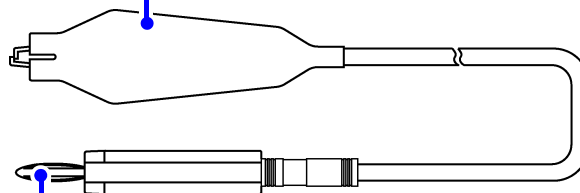

**High-voltage output plug**

Connect to the HIGH voltage output terminal on the instrument.

**Alligator Clip**

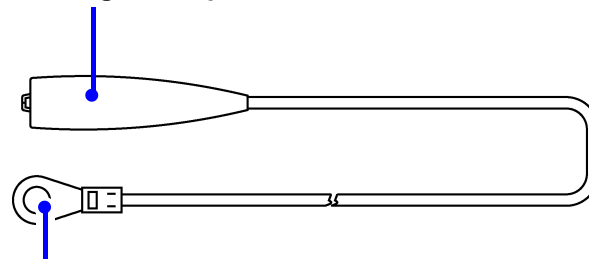

**Low-voltage output plug**

Connect to the LOW voltage output terminal on the instrument.

### 1.4 External Dimensions

Model 3174, 3174-01 AC Automatic Insulation/Withstanding HiTester

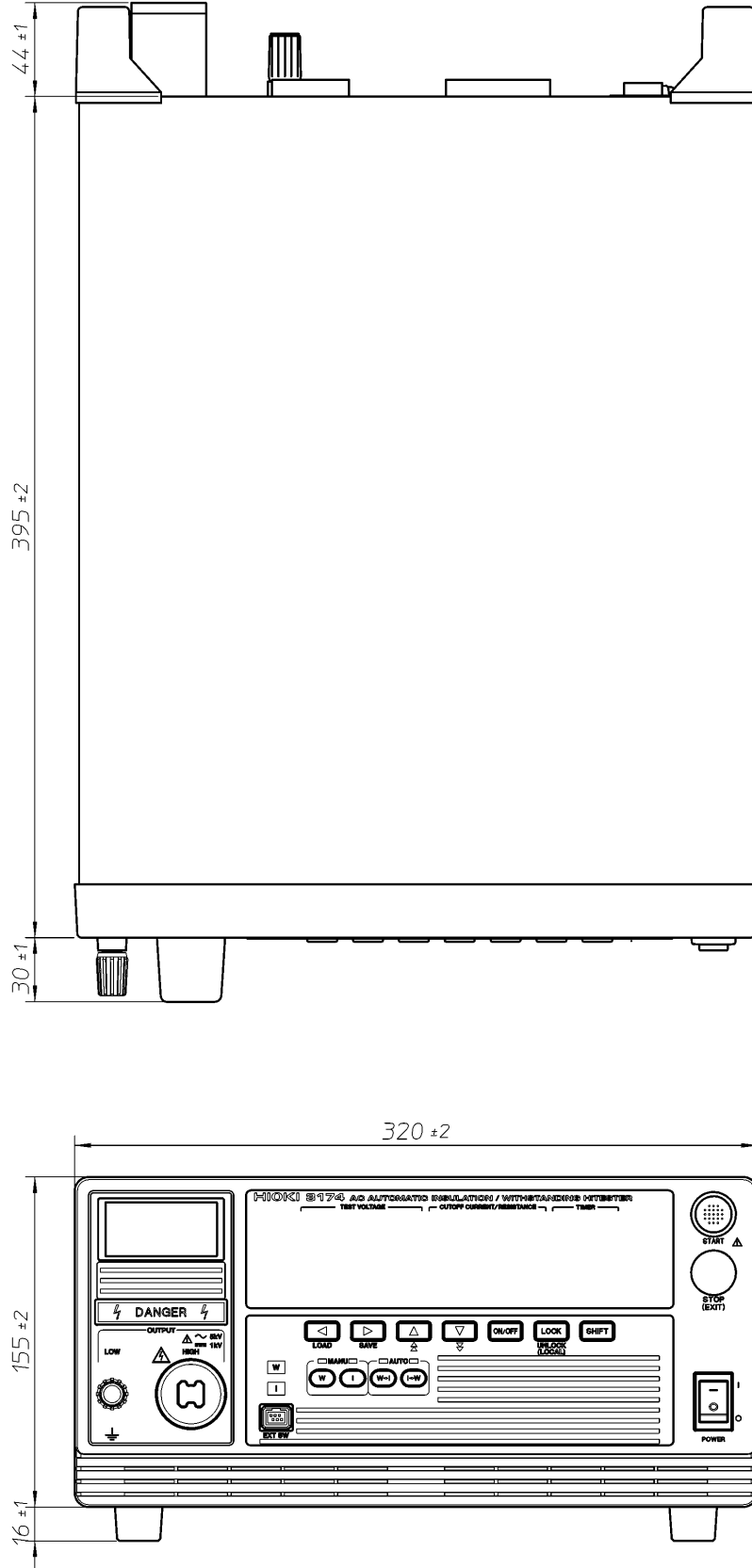





# Testing Arrangements

# Chapter 2

2

## 2.1 Arrangements Work Flow

Getting ready to start the test.

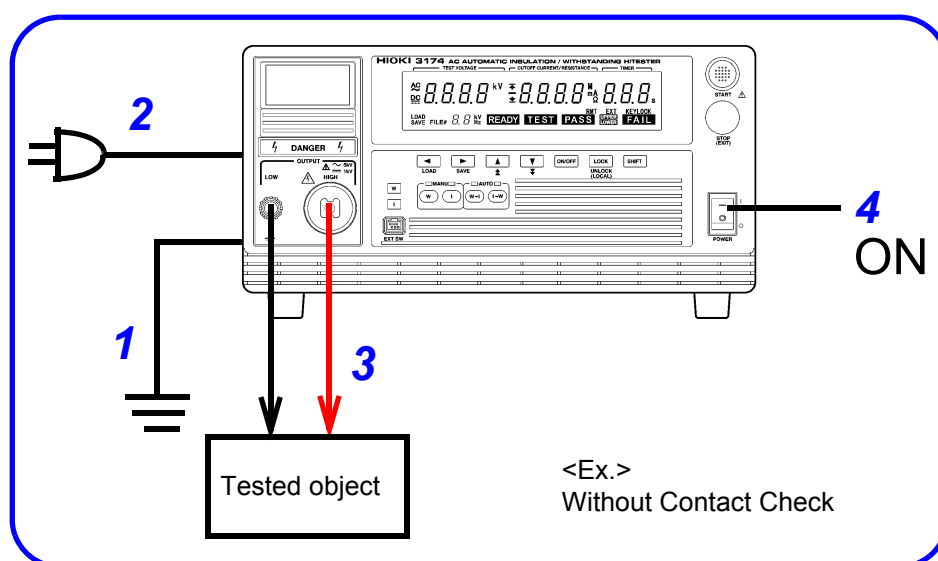

**1** "Connecting the Protective Conductor Terminal" (p. 18)

**2** "Connecting the Power Cord" (p. 19)

**3** "Connecting the Test Lead" (p. 20)

**4** "Turning the Power On and Off" (p. 24)

**5** "Pre-test Check" (p. 26)

### **NOTE**

To carry out a safer test

- The Remote Control Box to start or stop the test can be used.  
"Appendix1 Remote Control Box" (p. A1)
- The instrument can be controlled with EXT I/O, RS-232C or GP-IB (only for 3174-01).  
"Chapter 8 External Interface" (p. 103)  
"Chapter 9 RS-232C/GP-IB Interface" (p. 121)

## 2.2 Connecting the Protective Conductor Terminal

To carry out the test safely, connect the protective conductor terminal found on the back of the instrument to earth.

If the ground-type double-pole power cord that is supplied with the instrument is used, the instrument is automatically grounded.



To avoid electric shock, observe the following.

- Connect the protective conductor terminal to earth (earth ground) before making any other connections.
- Be sure to connect the protective conductor to earth (earth ground).

Rear panel

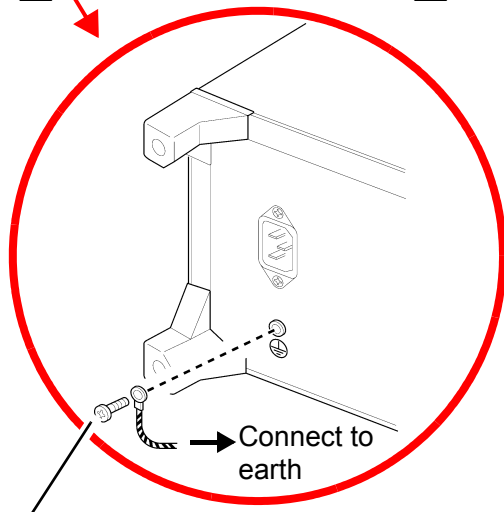
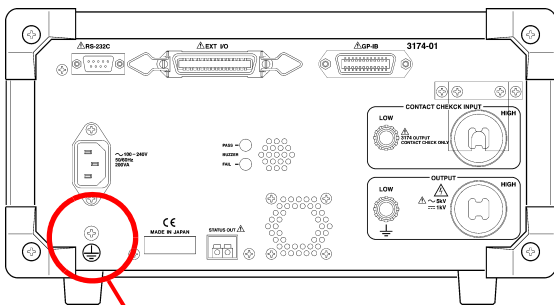

Protective conductor terminal

Prepare:

Phillips-head screwdriver, Earth wire or cable

1. Make sure that the power switch is turned off.
2. Using a Phillips-head screwdriver, remove the protective conductor terminal from the rear of the instrument.
3. Connect an electric wire with a sufficient current capacity to the protective conductor terminal.  
(A wire with a diameter of more than  $1.25\text{mm}^2$  is recommended.)
4. Secure the wire using a Phillips-head screwdriver.
5. Ground the other end of the wire or cable.



## 2.3 Connecting the Power Cord

Connect the power cord to the power inlet on the back of the instrument and the plug to the wall socket to provide power to the instrument.



To avoid electrical accidents and to maintain the safety specifications of this instrument, connect the power cord provided only to a 3-contact (two-conductor + ground) outlet.



Make sure the power is turned off before connecting or disconnecting the power cord.

Rear panel

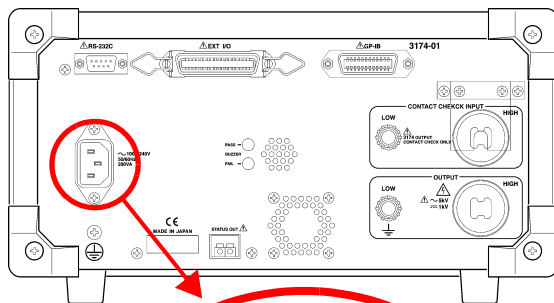

1. Make sure that the power switch is turned off.
2. Connect the power cord provided to the power inlet on the back of the instrument.
3. Insert the plug into the grounded outlet.

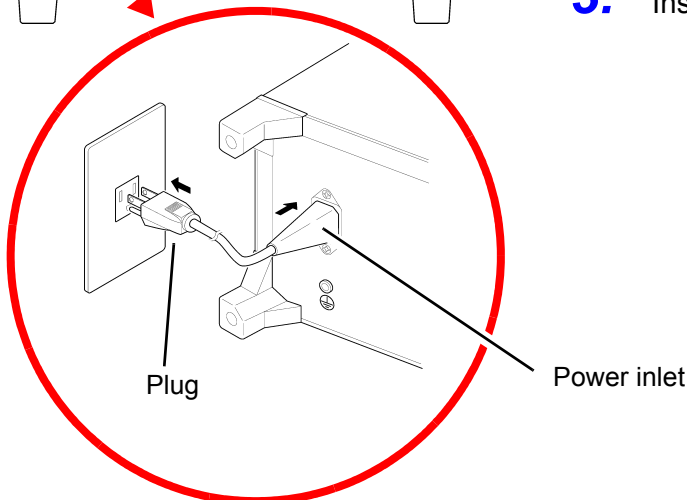

## 2.4 Connecting the Test Lead

Connect the 9615 H.V. Test Lead to the Voltage Output Terminal on the front of the instrument. When using Contact Check, connect to the Contact Check Terminal on the back as well.

### **DANGER**

- Before using the instrument, make sure that the insulation on the test leads is undamaged and that no bare conductors are improperly exposed. Using the instrument in such conditions could cause an electric shock, so contact your dealer or Hioki representative for replacements. (Model 9615 H.V.TEST LEAD)
- To avoid shock and short circuits, turn off power before connecting test leads.
- To avoid electric shock, make sure the test lead is securely connected before starting a test, as a loose test lead can cause a hazard when a voltage is output.
- Never touch the voltage output terminals, test lead, or the tested object during a test (when **TEST** is light up).
- Voltage may still remain on the voltage output terminal even after the test has completed. Confirm that no more voltage is left on the voltage output terminal when touching the voltage output terminals, test lead, or the tested object.
- To avoid electric shock, make sure the power is switched off before connecting a ferrite or resistor to remove noise.

### NOTE

- Inaccuracy in measurement may occur during insulation-resistance test if the instrument is put in a humid place so try to avoid doing so. If there is a possibility of the test lead becoming too humid, protecting the test lead with desiccant is recommended. If the test lead touches other metals, leakages in electric current may increase so be careful when coiling the test lead to avoid touching other parts.
- Do not allow the test lead used for Contact Check (HIGH, LOW terminals) to directly touch the test lead for the voltage output terminals (HIGH, LOW terminals) as this may make detecting loose connection difficult.
- If the HIGH and LOW voltage output terminals short-circuit or a dielectric breakdown occurs in the tested object during the test, noise will be generated and such noise may lead to a malfunction of this instrument or of a nearby electronic device. If this problem occurs, connect a ferrite core or a resistor to the H. V. Test Lead (high voltage side). When using a resistor, choose one appropriate for the power rating and withstand voltage. Also, be alert to any drop in test voltage.
- Do not the test lead and the EXT/IO cable arranged closely to each other. Doing so may lead to a malfunction of the external control due to a noise.

## 2.4.1 When using the Contact Check Function

When using the Contact Check Function, connect the test lead as follows. On the usage of Contact Check, see "2.6 Pre-test Check" "3.1.7" "4.1.5 Setting the Confirmation Voltage used for upper and lower-limits for Contact Check".



To prevent electric shock, when the **DANGER** lamp is lit or during the test, never touch the voltage output terminals, test lead, or the tested object.

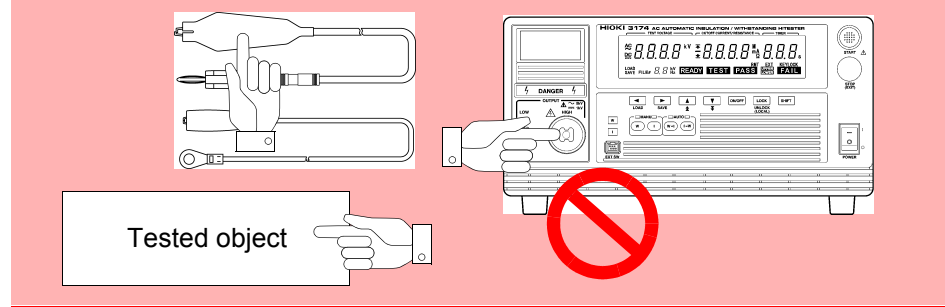

### When the front terminal is used

The H.V. Test Lead  
(low voltage side)

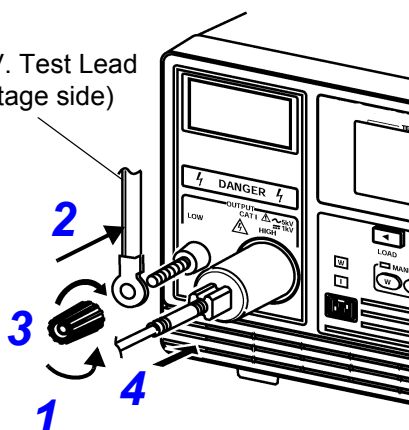

### When the back terminal is used

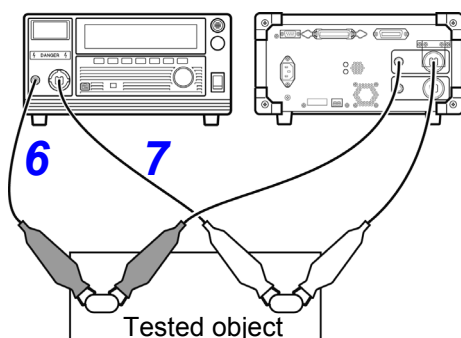
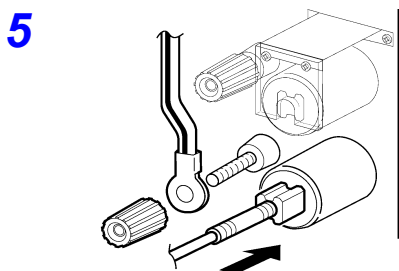

1. Remove the LOW voltage output terminal by turning it counterclockwise.
2. As shown in the left figure, insert the plug on the H.V. Test Lead (low voltage side).
3. Secure the LOW voltage output terminal by turning it clockwise.
4. Connect the plug on the H.V. Test Lead (high voltage side) to the HIGH voltage output terminal.
5. Connect in the same way when using the voltage output terminals on the back of the instrument as well.
6. Connect the test lead of the LOW voltage output terminal to the tested object. Ensure the connection is secure so that it will not come off during the test.
7. Connect the test lead of the HIGH voltage output terminal to the tested object as well.

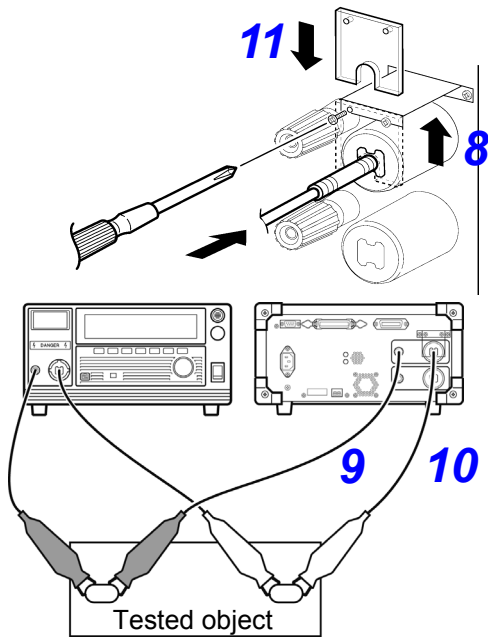

8. Remove the slip protection plate of the terminals for Contact Check and connect the test leads in the same way as steps 2 to 4.
9. Connect the test lead of the LOW Contact Check terminal to the tested object. Make sure the probe on the LOW Contact Check terminal side does not directly touch the probe on the LOW Voltage Output Terminal side during this process. Ensure the connection is secure so that it will not come off during the test.
10. Connect the probe on the HIGH Contact Check terminal side to the tested object as well.
11. Put back the slip protection plate after connection.

## Contact check function

By measuring the terminal voltage of the tested object, it is possible to confirm whether a test voltage is supplied to the tested object or not (Contact check function).

To use the Contact check function, besides the test output terminal, a set of 9615 H.V. Test Lead for test is necessary. (optional)

For this instrument, the voltage detected by the Contact check terminal will be differentiated from the test voltage and referred to as the contact voltage.

When the Contact voltage is smaller than the pre-set lower-limit voltage for contact check, broken wire or poor connection is suspected and a contact error will be displayed (Refer to "3.1.7", "4.1.5 Setting the Confirmation Voltage used for upper and lower-limits for Contact Check", "11.3 Error Indication" for errors). By setting an upper-limit voltage for Contact check, detection for any abnormality (supply of voltage higher than the pre-set value) in the output voltage is possible. When the Contact check terminal is connected to the tested object, ensure that the test lead for the Contact check does not directly touch the test lead for the test as shown in the diagram (ensure that the test lead for the Contact check touches the test lead for the test through the terminal for the tested object).

If the test lead for the Contact check directly touches the test lead for the test, a broken wire will be detected but a supply of test voltage to the tested object cannot be confirmed.

### **NOTE**

- When the contact check terminal on the LOW side is connected not to the tested object but to GND, an accurate contact check cannot be carried out. Ensure that the contact check terminal on the LOW side does not touch the GND even when it is removed.
- A voltage of approximately DC15 V runs through the contact check terminals. During insulation-resistance measurements, when the LOW Contact Check terminal is connected to the HIGH measurement terminal, a voltage of approximately 15 V will be indicated however this is not a malfunction.

## 2.4.2 When not using the Contact Check Function

When not using the Contact Check Function, connect the test lead as follows.

### When the front terminal is used

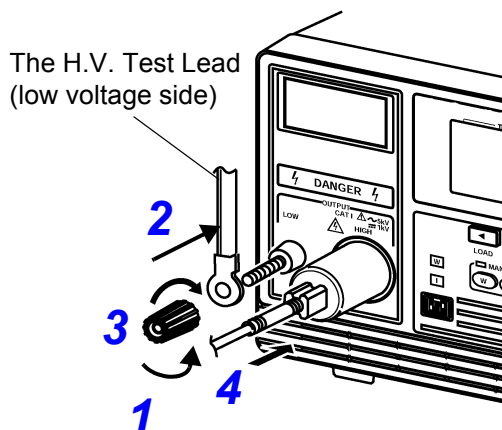

### When the back terminal is used

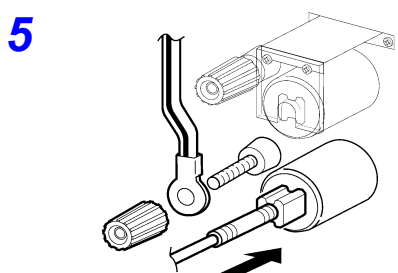

1. Remove the LOW voltage output terminal by turning it counterclockwise.
2. As shown in the left figure, insert the plug on the H.V. Test Lead (low voltage side).
3. Secure the LOW voltage output terminal by turning it clockwise.
4. Connect the plug on the H.V. Test Lead (high voltage side) to the HIGH voltage output terminal.
5. Connect in the same way when using the voltage output terminals on the back of the instrument as well.
6. Connect the test lead of the LOW voltage output terminal to the tested object. Ensure the connection is secure so that it will not come off during the test.
7. Connect the test lead of the HIGH voltage output terminal to the tested object as well.

## 2.5 Turning the Power On and Off

### **! WARNING**

Before turning the instrument on, make sure the supply voltage matches that indicated on its power connector. Connection to an improper supply voltage may damage the instrument and present an electrical hazard.

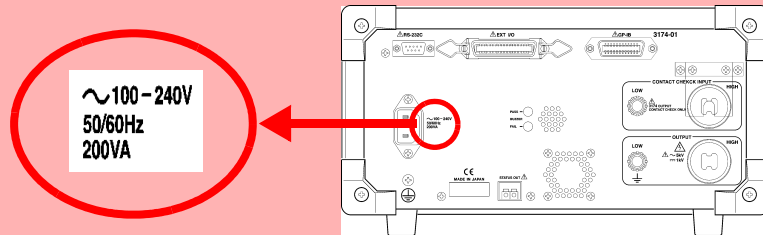

### **! CAUTION**

To avoid damaging the power cord, grasp the plug, not the cord, when unplugging it from the power outlet.

### **NOTE**

- Allow 10 minutes warming up after powering on. The Remote Control Box, external I/O device, RS-232C interface, and GP-IB interface are active only when they are connected prior to startup. If these devices are connected after the power is turned on, thus causing a malfunction.
- After the power has been switched off, wait for about 5 minutes before turning on the power again.

## Turning Power On

Front panel

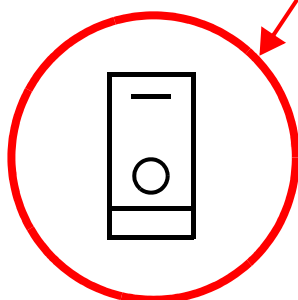
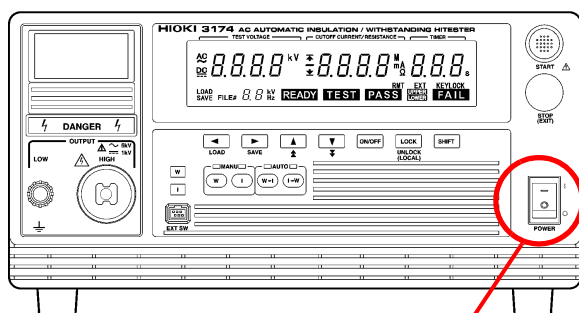

1. Turn the power switch to on ( I ).
2. The "3174" (model name) and software version are displayed on the screen.

```
3174 1.00 r 5.0
```

Model name

Software version

(This diagram shows version 1.00.)

State of interface

"rS.0": RS-232C 9600 bps

"rS.1": RS-232C 19200 bps

"G.XX": GP-IB address XX

3. When the **READY** lamp is lit (it does not light up in the Double Action mode), the keys are ready for operation."6.1.3 Double Action" (p. 81)

## Turning Power Off

Front panel

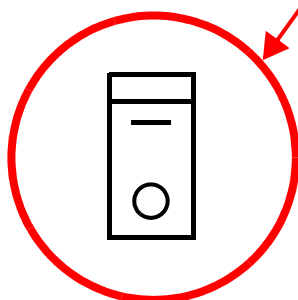
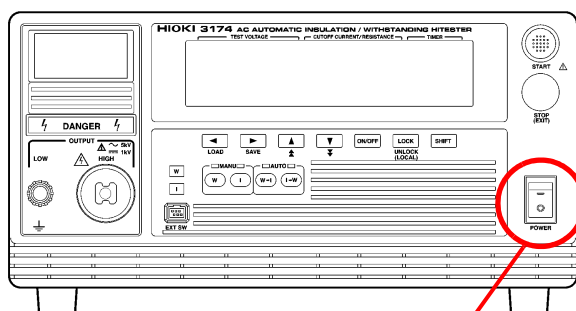

1. For safety reasons, check the following.
  - Test has completed
  - The **DANGER** lamp is off.
  - The **READY** lamp is lit.
2. Turn the power switch to off ( O ).

## 2.6 Pre-test Check

For safety reasons, check the following before starting test.

### START key, STOP key

For safety reasons, switch off the power and pull the electric plug from the socket before carrying out the check.

1. Press the center of the **START** key and **STOP** key in the front panel slowly with your finger to confirm the feel of the key clicking. Pressing the side of the key will make it difficult to feel the click.  
(The feel of the click will be easier to understand when you press the key a few times or compare it with the **STOP** key.)

\* Feel of the click

When you press the key slowly, you will feel an initial resistance which seems to be preventing the key from going down further. Press the key harder and you will feel the clicking of the key.

2. The key is working properly if you feel the click.
3. The key may be damaged if you do not feel the click.  
Contact your dealer or Hioki representative.

### Breaking current

Before starting the withstanding test, check whether electric current has been shut out when the pre-set voltage is outputted.

#### **NOTE**

Recommended Insulation: High voltage-high insulation flat chip resistors  
GS series (from KOA Corporation) or similar products  
Note the usage voltage and power.

1. Prepare a resistor with a resistance smaller than that of the calculation result from the test-voltage value and test upper-limit test value (breaking current) that are preset in the withstand-voltage test. When selecting the resistance, ensure that the maximum voltage usage is higher than the test voltage and the rated power is higher than the value which is calculated from the test voltage and resistance values.

$(\text{Test-voltage}) \div (\text{Breaking current}) > \text{Resistance}$

$(\text{Test-voltage}) < \text{Maximum usage voltage of pre-set resistance}$

$\text{Square of test-voltage} \div \text{Resistance} < \text{Rated power of pre-set resistance}$

2. Set an upper-limit test value.
3. Connect the resistor that you prepared to the test lead.
4. Start the test. Confirm that the current is cut off when the preset voltage is output. (i.e., make sure the instrument is in the FAIL state).



## Measured resistance

Before starting the insulation-resistance test, check that the resistance value for measurement is the same as the pre-set value.

### NOTE

Recommended Insulation: High voltage-high insulation flat chip resistors  
GS series (from KOA Corporation) or similar products

Note the usage voltage and power.

1. Prepare a resistance with a value which is higher than the lower-limit test value but close to it. When selecting the resistance, ensure that the maximum voltage usage is higher than the test voltage and the rated power is higher than the value which is calculated from the test voltage and resistance values.

(Test-voltage) < Maximum usage voltage of pre-set resistance

Square of test-voltage ÷ Resistance < Rated power of pre-set resistance

2. Set a test voltage.
3. Connect the resistor that you prepared to the test lead.
4. Make sure that the resistance measured matches the resistor that you prepared.

## Inter-lock

If the Inter-lock function is set, make sure the Inter-lock function works properly before starting test.

See "8.3 Inter-lock Function" (p. 111)

## Confirming the Contact Check Function

Check whether the Contact Check Function is functioning properly.

For safety reasons, carry out the check only after removing the high voltage probe on the voltage output terminal side from the instrument.

1. Set the upper-limit and lower-limit voltages of the Contact Check Function.  
Withstand-voltage test : "3.1.7 Setting the Confirmation Voltage used for upper and lower-limits for Contact Check" (p. 38)  
Insulation-resistance test : "4.1.5 Setting the Confirmation Voltage used for upper and lower-limits for Contact Check" (p. 55)
2. Connect the low voltage side for probe for Contact Check and low voltage side for probe for voltage output terminal side after removing the high voltage probe on the voltage output terminal side.
3. Start testing and confirm "**UPPER LOWER FAIL**" appears immediately. Then, the test is stopped with an error number display. This is the correct function of the contact check.  
If the test is completed and either "**TEST**", "**UPPER FAIL**", "**LOWER FAIL**" or "**PASS**" appears, the Contact Check Function is not ON or the instrument is defective.
4. Start the test after separating the low voltage side probe for Contact Check from the low voltage side of the voltage output terminal side probe.  
Confirm that there is a beeping sound from the instrument and **UPPER / LOWER FAIL (Err4)** appears. If the test starts, this could mean that the Contact Check Function is OFF or there is a malfunction.

## Self-testing of the Contact Check Function

After finishing laying out the wires for the test, hold down the **SHIFT** key and press the **START** key to start the Contact Check self-testing (The wire layout for the test is the actual test wire layout or the wire layout used during the pre-test check).

1. Connect the instrument to the tested object following the instructions in "Chapter 2 Testing Arrangements" (p. 17) in this manual. Connection used in the pre-test checks will work as well.
2. Set the test conditions (test voltage, upper and lower electric current limits or insulation-resistance upper and lower limits) following the instructions in "Chapter 3 Withstand- Voltage Test" (p. 29), "Chapter 4 Insulation- Resistance Test" (p. 47) in this manual.
3. Check that the surrounding is clear then in the READY status, hold down the **SHIFT** key and press the **START** key. Contact Check self-testing will start. The test-frequency and initial voltage for ramp-up parts will display "CC". Pressing the **SHIFT** and **START** keys in status other than READY will be ignored.
4. During the self-testing, the following will be checked and if no abnormality is detected, **PASS** will be indicated and the instrument will return to READY status.  
If an abnormality is detected, an error number (see "11.3 Error Indication" (p. 200)) will be indicated followed by **UPPER LOWER FAIL**.

1. Test voltage check  
Check if the output voltage is similar to the pre-set test voltage  
Judgement includes error margin of the instrument's voltmeter
2. Check for voltage in excess of upper-limit Contact Check voltage for H side terminal  
The instrument will intentionally output a voltage higher than the pre-set Contact Check upper-limit voltage to check for excess upper-limit voltage.  
This test will not be carried out if the Contact Check upper-limit value is not set (during OFF)
3. Check for voltage below lower-limit Contact Check voltage for H side terminal  
The instrument will intentionally output a voltage lower than the pre-set Contact Check lower-limit voltage to check for voltage below the lower-limit voltage.  
This test will not be carried out if the Contact Check lower-limit value is not set (during OFF)

### **NOTE**

- Take note that checks for the L side Contact Check will not be carried out. Be sure to carry out the check for the L side using the procedures used for pre-test check for the Contact Check Function.
- As the upper-limit voltage for Contact Check is 5.00 kV, the judgment may be inaccurate if the test voltage is set at 5.00 kV.
- As the lower-limit voltage for Contact Check is 0.20 kV, the judgment may be inaccurate if the test voltage is set at 0.20 kV.

# Withstand-Voltage Test

## Chapter 3

3

This chapter describes how to set withstand-voltage test conditions and the proper testing procedure. Read "Chapter 2 Testing Arrangements" (p. 17), and make the necessary preparations for testing.

Refer to "Chapter 5 Automatic Test" (p. 69) for carrying out withstanding and insulation-resistance tests consecutively.



To prevent electric shock, when the **DANGER** lamp is lit or during the test, never touch the voltage output terminals, test lead, or the tested object.

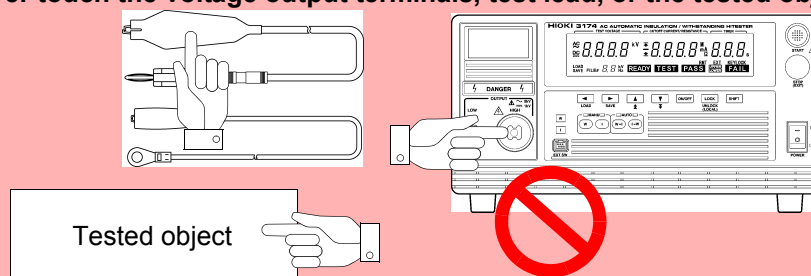

- To prevent electric shocks, do not connect to or remove the test lead from the tested object when there is a voltage supply during the test. There is a danger of a voltage higher than the pre-set voltage being supplied due to the stabilization function of the voltage output. When this happens, the instrument may malfunction due to the noise produced.
- The instrument and peripheral electrical devices may not function properly when the tested object's insulation is broken or when the test leads are not connected properly. When this happens, connect a ferrite core or a resistor to the test lead on the high voltage side. Be careful of a dip in the test voltage caused by the rated power, withstanding voltage and resistor when choosing a resistor.
- Wear insulated gloves and confirm that automatic control is off before changing the tested object or touching the test lead and tested object directly.
- To increase test efficiency, this instrument can be controlled by EXT I/O or RS-232C and GP-IB and can start tests automatically. As a result, there is a danger of electric shock accidents. Measures to prevent people from coming near the instrument or the tested object unintentionally must be taken when starting the instrument automatically.



- When the tested object in use shows dependency on voltage (impedance of ceramic condenser, etc.), the waveforms of the output voltage may become distorted. The tested object may malfunction depending on the distortion of the waveforms.
- When the tested object in use possesses an inductivity like a coil, a voltage higher than the pre-set voltage may appear transitionally, causing damage in the tested object.

Select the Withstand-voltage test mode

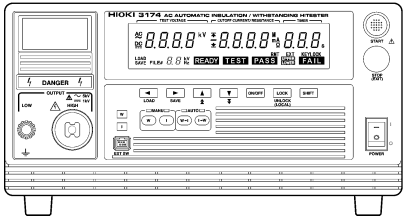
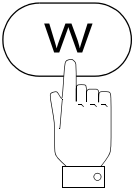

Set test conditions

- "3.1.1 Setting the Test-Voltage Value" (p. 32)
- "3.1.2 Setting the Upper (Lower) Limit Value" (p. 33)
- "3.1.3 Setting the Test Time Timer" (p. 34)
- "3.1.4 Setting the Ramp-up (Ramp-down) Time Timer" (p. 35)
- "3.1.5 Setting the Test-Frequency" (p. 36)
- "3.1.6 Setting the Initial voltage for ramp-up" (p. 37)

Starting a test



Press the **START** key to start a test. (p. 40)

Displaying the test result

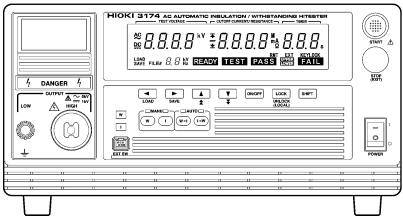

PASS

Test result (p. 42)

## 3.1 Setting the Test-Conditions

For safety reasons, be sure to carry out pre-test check (p. 26) before setting the test conditions.

Setting the test conditions.

Pre-set test conditions can be retrieved to carry out the test.

See "7.2 Loading the Test Conditions" (p. 102)

### Test setting state

When **READY** lights up on the screen, pressing the ◀ / ▶ key will change the status to the test conditions status. The test voltage will flash (**READY** will go off). Set the test conditions in this status.

When Double Action is set, ◀ / ▶ key is enabled even when **READY** is not lit.

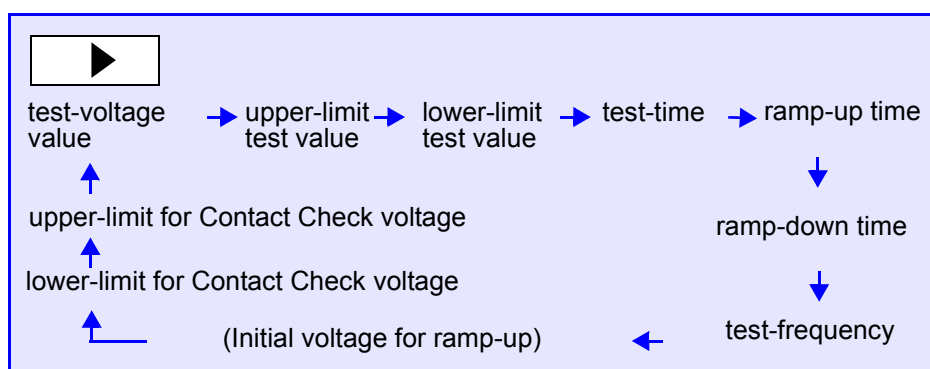
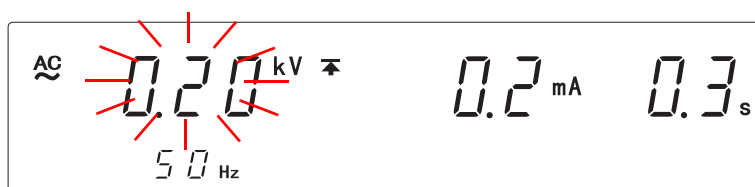

If the item is not needed in the test, set it to OFF using the **ON/OFF** key. However, the test-voltage value, the upper-limit test value, and the test-frequency cannot be set to OFF.

Pre-set test conditions can be saved. (p. 99)

The initial voltage for ramp-up is displayed only when ramp-up time is set.

### NOTE

- In the test setting state, the test cannot start. Test will only start when **READY** lights up.
- Indicates the voltage for the output terminal in Test-voltage value in **READY** and test status.
- When **READY** lights up,  $\overline{\text{READY}}$  for EXT I/O turns Lo at the same time.

### 3.1.1 Setting the Test-Voltage Value

Set a test-voltage value. When the test is started, the pre-set voltage will be supplied to the tested object from the voltage output terminal via the test lead. The test will not start if the load is large and the output voltage does not reach  $\pm 30$  V of the set test-voltage. (**TEST** flashes.)

If the output voltage fails to reach  $\pm 30$  V of the test-voltage within approximately 5 seconds after completion of the ramp-up time, the instrument will change to the FAIL state and the test will be terminated. Also, if the output voltage deviates from test-voltage and does not return to  $\pm 30$  V of the set value within 5 seconds, the test is terminated.

1.



When **READY** is lit on the screen, press the **▶** key to get to the test conditions mode.

\* When Double Action is set, **◀ / ▶** key is enabled even when **READY** is not lit.

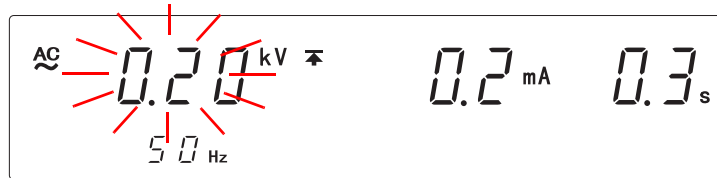

2.

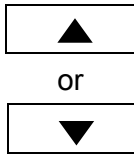

Press the **▲ / ▼** keys to set the test-voltage value.

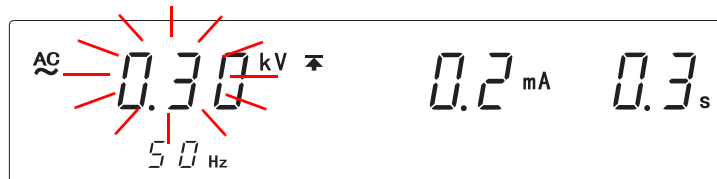

<Ex.> Set to 0.3 kV.

Setting range: 0.20 to 5.00 kV (The value changes by 0.01 kV.)

To change the value by 0.1 kV, while holding down the **SHIFT** key, press **▲ / ▼** keys.

3.



Press the **STOP** key to complete the setting value. The instrument reverts to the READY state.

To continue to the setting for the next item, press the **▶** key.

#### **NOTE**

- The output voltage can be restricted to prevent accidents caused by improper settings. (When the default is set to 5.00 kV.)  
See "6.1.5 Output-Voltage Restricting" (p. 83)
- Note that the instrument does not start test if the test-voltage value is greater than the output-voltage restricting value.  
See "6.1.5 Output-Voltage Restricting" (p. 83)
- The tested object may damage if a voltage higher than necessary is supplied. Be careful when setting the output voltage to ensure that the tested object does not receive a voltage higher than necessary.
- The tested object may damage if a voltage is supplied longer than necessary. Be careful when setting the test time.
- Refer to relevant safety regulations and laws when setting the test voltage value.

### 3.1.2 Setting the Upper (Lower) Limit Value

Set a upper-limit test value and a lower-limit test value. For example, when the upper-limit (lower-limit) test value is set at 10 mA, a “PASS” will be shown when a current less than (more than) 10 mA is supplied to the tested object. If no lower-limit test value is required, set it to “OFF” using the **ON/OFF** key. However, the upper-limit test value cannot be set to OFF.



Press the ► key to move the flashing cursor to the upper-limit test value.

◀ is lit.

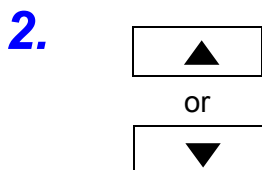

Press the ▲ / ▼ keys to set the upper-limit test value.

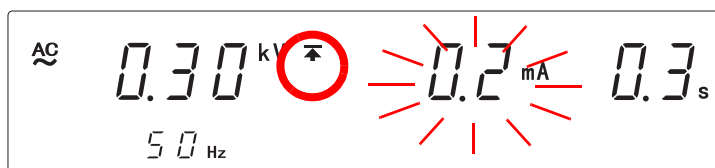

<Ex.> Set to 0.2 mA.

Setting range: 0.1 to 20.0 mA (The value changes by 0.1 mA.)

To change the value by 1 mA, while holding down the **SHIFT** key, press ▲ / ▼ keys.

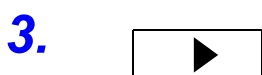

Press the ► key to move the flashing cursor to the lower-limit test value.

▶ is lit.

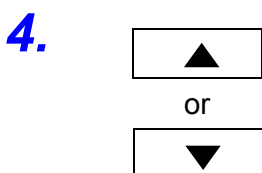

Press the ▲ / ▼ keys to set the lower-limit test value.

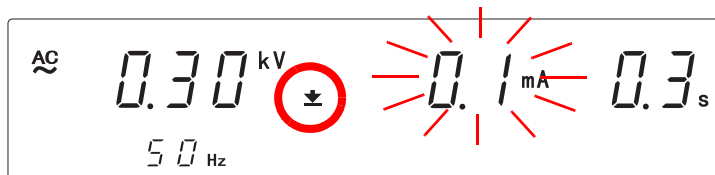

<Ex.> Set to 0.1 mA.

Setting range: 0.1 to 19.9 mA (The value changes by 0.1 mA.)

If no lower-limit test value is required, set it to “OFF” using the **ON/OFF** key.

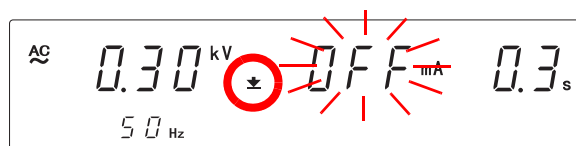

<Ex.> Set to OFF.



Press the **STOP** key to complete the setting value.

The instrument reverts to the READY state.

To continue to the setting for the next item, press the ► key.

#### **NOTE**

- The electric current range will be decided by the upper-limit test value (10 mA-range for “upper-limit test value ≤ 10.0 mA”, and 20 mA-range for “upper-limit test value > 10.0 mA”)
- The setting resolution of the upper (lower)-limit test value is 0.1 mA.
- The current measurement resolution during a test depends on the set upper-limit test value: 0.01 mA at 0.10 mA to 10.00 mA and 0.1 mA at 10.1 mA to 20.0 mA.
- If the set lower-limit test value is greater than the upper-limit test value, unable to get out of setting screen. In such a case, correct the upper- or lower-limit test value.
- A lower-limit test value is not necessary in the withstanding test but pre-setting it will allow the instrument to be used for simple Contact Checks.

### 3.1.3 Setting the Test Time Timer

When the test time timer is set, the test will automatically run and stop when the time is up. If no test-time timer is required, set it to "OFF" using the **ON/OFF** key.

1.



Press the ► key to move the flashing cursor to the test-time timer.

2.



Press the ▲ / ▼ keys to set the test-time timer.

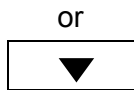

<Ex.> Set to 0.3 s.

Setting range: 0.3 to 999 s

- When the set time scale is 0.3 s to 99.9 s  
The value changes by 0.1 s. To change the value by 1 s, while holding down the **SHIFT** key, press ▲ / ▼ keys.
- When the set time scale is 100 s to 999 s  
The value changes by 1 s. To change the value by 10 s, while holding down the **SHIFT** key, press ▲ / ▼ keys.

If no test-time timer is required, set it to "OFF" using the **ON/OFF** key.

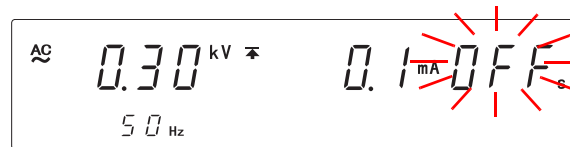

Set to OFF.

3.



Press the **STOP** key to complete the setting value.  
The instrument reverts to the READY state.

To continue to the setting for the next item, press the ► key.

#### **NOTE**

- The setting resolution of the test-time timer is 0.1 s between 0.3 and 99.9 s, and becomes 1 s between 100 and 999 s.
- If a test-time timer has been set, the reduction timer will operate during the test.
- If the test-time timer is set to OFF, the time elapsed during the test is displayed. When this time exceeds 999 s, "- - -" will appear, but the test will continue.
- In the withstand-voltage test, because of the circuit response time, the output voltage may take some time to reach the test voltage depending on the load. As a result, the actual test time is "time taken to reach the accurate test voltage + pre-set test time".



### 3.1.4 Setting the Ramp-up (Ramp-down) Time Timer

Ramp-up time means the time to increase the voltage until it reaches the set test-voltage value set in the "Setting the Test-Voltage Value" (p.32). Ramp-down time means the time to decrease the voltage upon completion of the test time. When the ramp-up time and ramp-down time are set, the test voltage during the test can be controlled.

**TEST** flashes during the ramp-up time and the ramp-down time. If no ramp-up (ramp-down) time timer is required, set it to "OFF" using the **ON/OFF** key.

1.



Press the ► key to move the flashing cursor to the ramp-up time timer.

2.



Press the ▲ / ▼ keys to set the ramp-up time timer.

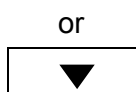

<Ex.> Set to 0.1 s.

Setting range: 0.1 to 99.9 s (The value changes by 0.1 s.)

If no ramp-up time timer is required, set it to "OFF" using the **ON/OFF** key.

3.



Press the ► key to move the flashing cursor to the ramp-down time timer.

4.



Press the ▲ / ▼ keys to set the ramp-down time timer.

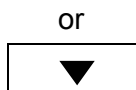

<Ex.> Set to 0.1 s.

Setting range: 0.1 to 99.9 s (The value changes by 0.1 s.)

If no ramp-down time timer is required, set it to "OFF" using the **ON/OFF** key.

5.



Press the **STOP** key to complete the setting value.

The instrument reverts to the READY state.

To continue to the setting for the next item, press the ► key.

**NOTE**

- During the ramp-down time, screening using the upper- or lower-limit test value is invalid.
- A ramp-up and ramp-down time of 0.1 seconds is always inserted even when the ramp-up (Ramp-down) time timer is set to OFF.
- Ramp-down time will not be inserted during a forced termination.
- Due to the response time of the circuit, sometimes immediately after the withstand voltage test has started, both the time taken for the output voltage to reach initial voltage of ramp-up and the time taken for the output voltage to reach the accurate test voltage after the ramp-up time has ended, may take longer, depending on the loads. As a result, the actual test time will be; time taken for the output voltage to reach the initial voltage level + setting ramp-up time + time taken for the output voltage to reach the accurate test voltage level + test time + ramp-down time.

(Refer to the diagram in "3.4 Displaying the Test Result" (p. 44).)

### 3.1.5 Setting the Test-Frequency

In the withstand-voltage test, the test-frequency (50 Hz/ 60 Hz AC) can be selected.

1.



Press the ► key to move the flashing cursor to the test-frequency.

2.



Press the ▲ / ▼ keys to set the test-frequency.

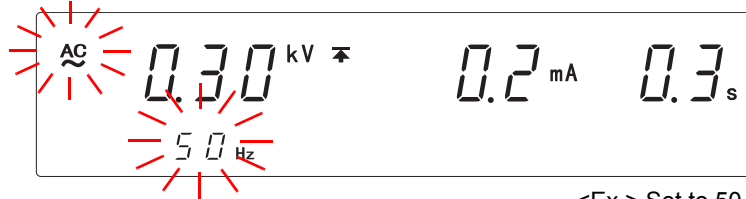
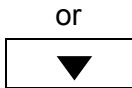

<Ex.> Set to 50 Hz AC.

Setting range: 50 Hz/ 60 Hz AC

3.



STOP

Press the **STOP** key to complete the setting value.  
The instrument reverts to the READY state.

To continue to the setting for the next item, press the ► key.

### 3.1.6 Setting the Initial voltage for ramp-up

When setting the voltage-raising time (ramp-up time), the initial value can be set by setting it as a proportion of the test voltage. The default value is 0.0 and the initial voltage for ramp-up is 0 V.

1.



Press the ► key to move the flashing cursor to the Initial voltage for ramp-up.

In the frequency display, a double-digit voltage ratio (proportion of test voltage) will be shown to indicate the ramp-up initial voltage setting.

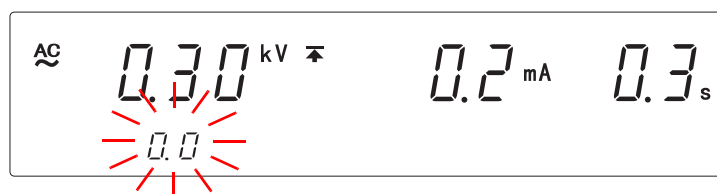

2.



or



Press the ▲ / ▼ keys to set the Initial voltage for ramp-up.

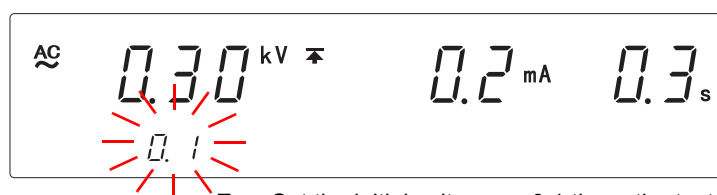

<Ex.> Set the initial voltage as 0.1 times the test voltage

Setting range: 0.0 to 1.0 (The value changes by 0.1.)

- Setting is not possible when the ramp-up time is OFF.
- When the test is started, a voltage indicated by the test voltage multiplied by the voltage ratio will be outputted. After that, it will use the pre-set “ramp-up time” to rise almost linearly until the test voltage is achieved.

3.



STOP

Press the **STOP** key to complete the setting value.  
The instrument reverts to the READY state.

To continue to the setting for the next item, press the ► key.

#### **NOTE**

- Setting is not possible if the ramp-up time timer is not set.
- If the voltage calculated from a proportion of the initial voltage and the pre-set voltage is less than 100 V, the initial voltage will be 100 V.
- Due to the response time of the circuit, sometimes immediately after the withstand voltage test has started, both the time taken for the output voltage to reach initial voltage of ramp-up and the time taken for the output voltage to reach the accurate test voltage after the ramp-up time has ended, may take longer, depending on the loads. As a result, the actual test time will be; time taken for the output voltage to reach the initial voltage level + setting ramp-up time + time taken for the output voltage to reach the accurate test voltage level + test time + ramp-down time.

### 3.1.7 Setting the Confirmation Voltage used for upper and lower-limits for Contact Check

Confirmation Voltage used for upper and lower-limits for Contact Check.

Contact Check can be carried out by measuring the terminal voltage of the tested object. When this function is pre-set, test abnormalities can be detected whenever the output voltage deviates from the pre-set ranges. The setting for the upper or lower limit voltage confirmation is the same as that used for the H side terminal Contact Check, but setting either the upper limit or the lower limit will also automatically allow for Contact Checks on the L side terminals.

By measuring the voltage on the H side terminals of the tested object, checks on whether an accurate voltage is supplied to the test terminals or not (whether the test lead is properly connected or not: Contact Check) can be carried out. When a value outside the range of the pre-set terminal voltage is achieved, an error number will show and the test will terminate.

When Contact Check Function is not in use, press the **ON/OFF** key to set to "OFF".

1.



Press the ► key to move the flashing cursor to the upper-limit confirmation voltage for Contact Check.

2.



or



Press the ▲ / ▼ keys to set the upper-limit confirmation voltage for Contact Check.

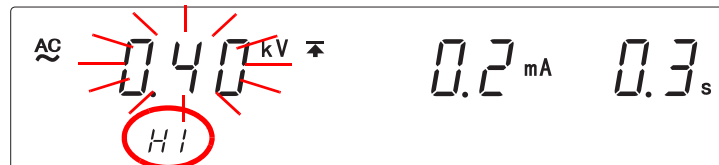

<Ex.> Set to 0.4 kV.

Setting range: 0.20 to 5.00 kV (The value changes by 0.01 kV.)

To change the value by 0.1 kV, while holding down the **SHIFT** key, press ▲ / ▼ keys.

If no upper-limit confirmation voltage for Contact Check is required, set it to "OFF" using the **ON/OFF** key.

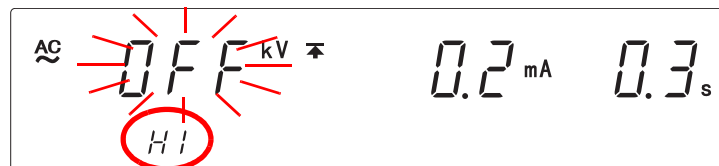

**Specify an upper evaluation-value for the contact check with errors the instrument develops in mind.**

3.



Press the ► key to move the flashing cursor to the lower-limit confirmation voltage for Contact Check.

4.



or



Press the ▲ / ▼ keys to set the lower-limit confirmation voltage for Contact Check.

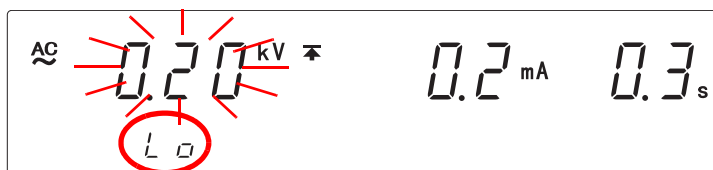

<Ex.> Set to 0.2 kV.

Setting range: 0.20 to 5.00 kV (The value changes by 0.01 kV.)

To change the value by 0.1 kV, while holding down the **SHIFT** key, press ▲ / ▼ keys. If no lower-limit confirmation voltage for Contact Check is required, set it to "OFF" using the **ON/OFF** key.

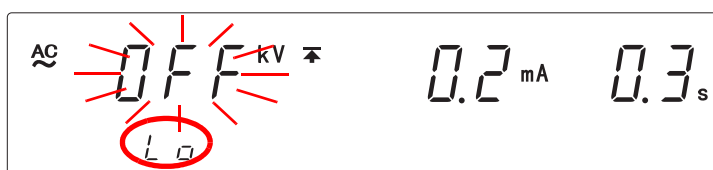

**Specify a lower evaluation-value for the contact check with errors the instrument develops in mind.**

5.



STOP

**NOTE**

Press the **STOP** key to complete the setting value.

The instrument reverts to the READY state.

To continue to the setting for the next item, press the ► key.

- A value for the Contact Check upper-limit confirmation voltage which is lower than the test voltage or a lower-limit voltage which is higher than the test voltage can be set but during this time, pressing the **START** key will not start the test.
- When contact error is detected, the following errors will be displayed and the test will terminate.

**Err4** Contact error at the L side terminal

**Err5** Test voltage setting lower than the lower-limit confirmation voltage (wrong setting)

**Err6** Output measurement voltage lower than the lower-limit confirmation voltage (output abnormality)

**Err7** Contact voltage(p. 22) lower than the lower-limit confirmation voltage (measurement-type malfunction, contact error)

**Err8** Pre-set voltage higher than the upper-limit confirmation voltage (wrong setting)

**Err9** Output voltage higher than the upper-limit confirmation voltage (output-type or measurement-type malfunction)

\* Test for **Err6** and **Err7** will not be carried out during ramp-up and ramp-down.

\* When FAIL hold is not set, an error message will appear for about 0.3 seconds before returning to READY mode.

- Contact errors can be canceled merely by turning on the instrument after turning off it or by pressing the **STOP** key. Sending any communication commands cannot cancel errors.
- To prevent ramp-up function and fluctuations in output voltage loads, carry out the HIGH side terminal Contact Check only after the output voltage has reached the test voltage value.
- As the upper-limit voltage for Contact Check is 5.00 kV, the judgment may be inaccurate if the test voltage is set at 5.00 kV.
- As the lower-limit voltage for Contact Check is 0.20 kV, the judgment may be inaccurate if the test voltage is set at 0.20 kV.
- The detected voltage for the Contact Check is the average detected value. Therefore, if the waveform distortions are large, the margins of error from the test voltage display will also be large.

## 3.2 Starting a Test

Carry out the test after finishing setting the test conditions (p. 31).

For safety reasons, key lock is recommended. All keys except the **START** key and **STOP** key are disabled while the key-lock function is active. (p. 79)



To prevent electric shock, check the following before starting test.

Front panel

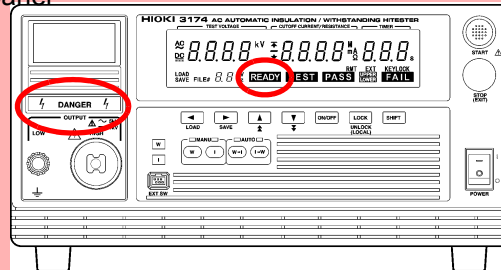

- The **DANGER** lamp is OFF.
- The **READY** lamp is lit (it is off in the Double Action mode).



- When the tested object in use shows dependency on voltage (impedance of ceramic condenser, etc.), the waveforms of the output voltage may become distorted. The tested object may malfunction depending on the distortion of the waveforms.
- Continuous output of a high voltage may heat the bottom of the instrument. To prevent from getting scalded, do not touch the bottom.

### NOTE

- There is a priority hierarchy for the **START** keys.  
Priority hierarchy: Remote Control Box > EXT I/O > Front panel of the 3174 (3174-01)  
Note that when a **START** key with a higher priority is in use, lower-priority keys are disabled.
- When the tested object in use possesses an inductivity like a coil, a voltage higher than the pre-set voltage may appear transitionally, causing damage in the tested object.
- The tested object may damage if a voltage higher than necessary is supplied. Be careful when setting the output voltage to ensure that the tested object does not receive a voltage higher than necessary.
- The tested object may damage if a voltage is supplied longer than necessary. Be careful when setting the test time.

1. Double action state **READY** will not be displayed because the default factory setting for this instrument is Double Action.

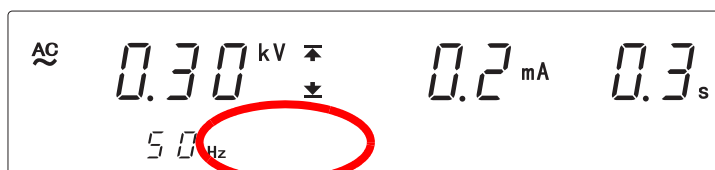

**READY** is not lit.

2.



STOP

Press the **STOP** key once in the beginning.

When the **STOP** key is pressed, **READY** will be shown for 0.5 seconds.

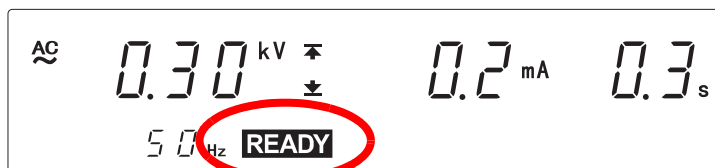

3.

(**READY** is lit)



START

To start the test, press the **START** key when **READY** is shown.  
The **DANGER** lamp on the front panel of instrument is lit.

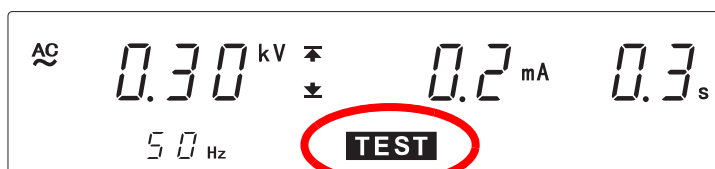

- **TEST** flashing on screen : Output voltage rising (within time shown on ramp-up timer). (FAIL will display if the current measurement value is higher than the upper-limit test value.)
- **TEST** lit up on screen : Output voltage has reached the test voltage. Test starts.
- "UP" display : ramping up
- "dn" display : ramping down
- To forcibly terminate the test, press the **STOP** key.  
The instrument will immediately stop outputting a voltage and switch to the **READY** state.

**WARNING**

If the **DANGER** lamp does not go off even after the test has finished, this could mean that some voltage stronger than the safe voltage (about AC 30 V or DC 60 V) still remains in the voltage output terminal. To prevent electric shock, never touch the voltage output terminals.

**NOTE**

Double Action can be released with the Option Setting.

In this case, **READY** will be displayed, and the test can be started by just pressing the **START** key.

See "6.1.3 Double Action" (p. 81)



Test does not start

- When lower-limit test value  $\geq$  upper-limit test value, unable to get out of setting screen.
- When the output-voltage restricting value (optional function)  $<$  test voltage value, the test will not start.

See "6.1.5 Output-Voltage Restricting" (p. 83)

To change the output voltage during a test

See "6.6 Changing the Output Voltage during the withstanding test" (p. 91)

To set the upper-limit test voltage for safety reasons  
(initial setting at 5.00 kV)

See "6.1.5 Output-Voltage Restricting" (p. 83)

# 3.3 Terminate the Test

When the test-time is set

Test will automatically stop when the test is carried out during the pre-set test time.

Front panel

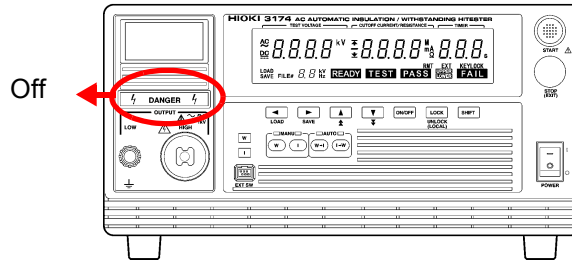

When the test-time has not been set

Press the **STOP** key to terminate the test.

Front panel

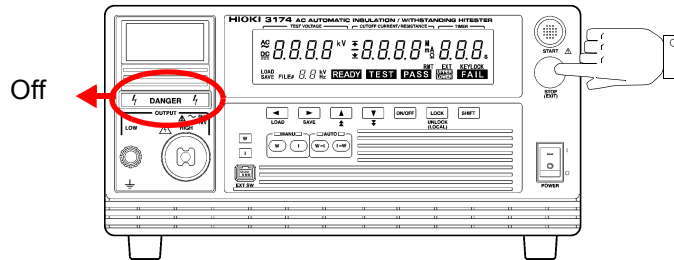

Forcibly terminate

Pressing the **STOP** key during the test will forcibly stop the test.

 Test forcibly stopped when **UPPER / LOWER FAIL** judgment is shown (**UPPER LOWER FAIL** all light up)

- During the test, if the output voltage deviates from test-voltage and does not return to  $\pm 30$  V of the set value within 5 seconds.
- If the output voltage does not reach  $\pm 30$  V of the set test-voltage.
- If the output voltage fails to reach  $\pm 30$  V of the test-voltage within approximately 5 seconds after completion of the ramp-up time.

**UPPER FAIL** or **LOWER FAIL**

- If the measured-current value exceeds the upper- or lower-limit test value during the test-time.

To show test results even when test is forcibly terminated  
 See "6.3 Evaluate even for forced termination of test" (p. 88)

To hold the value shown when test is forcibly terminated  
 See "6.2.3 STOP Hold" (p. 87)





Never touch the voltage output terminals, test lead, or the tested object until the **DANGER** lamp has gone off and the output voltage indicator shows 0.00V.

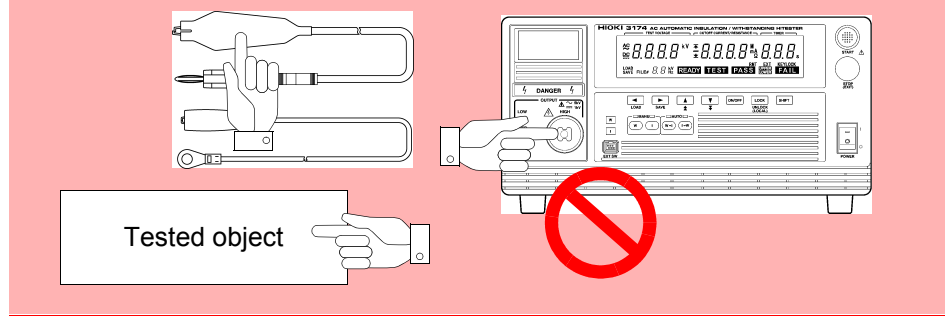

When a test object that contains a capacity component is subjected to a test, the object might remain electrically charged, thereby causing an electric shock.

### NOTE

- The instrument does not return to the READY state until the **DANGER** lamp goes out upon completion of the test. Until the instrument returns to the READY state, no key operation is accepted.
- With an optional setting, the instrument can change to the READY state, regardless of the **DANGER** lamp indication, upon completion of the test.

See "6.1.4 START Protection" (p. 82)

In such a case, the voltage output terminals may contain residual electricity even when the instrument is in the READY state.

# 3.4 Displaying the Test Result



Even following a test, there may be a residual voltage at the output terminal. Therefore, to prevent electric shock, check the following before touching the output-voltage terminal, test lead, or tested object, make sure that no high voltage is being applied between the output terminals.

Front panel

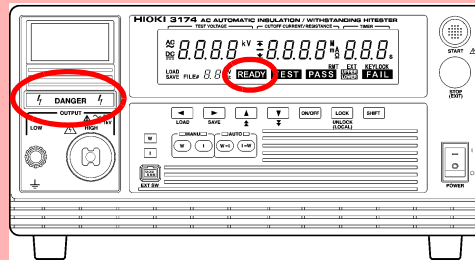

- The **DANGER** lamp is OFF.
- The **READY** lamp is lit (it is off in the Double Action mode).

The test result is displayed on the screen. "PASS" or "FAIL" screening is conducted based on whether a measured-current value exceeds the upper- or lower-limit test value within the set test-time.

Display	Test result
<b>PASS</b> is lit	<b>PASS</b> will appear when the current measurement value is lower than the upper-limit test value and higher than the lower-limit test value.
<b>FAIL</b> is lit	<b>FAIL</b> will appear when the current measurement value is higher than the upper-limit test value or lower than the lower-limit test value.

If the output voltage fails to reach  $\pm 30$  V of the test voltage within approximately 5 seconds after the **START** key is pressed (or after the ramp-up time has elapsed, if the ramp-up time has been set), the instrument returns a UPPER/ LOWER FAIL result.

In the following cases, tests are terminated, and **UPPER** , **LOWER** , and **FAIL** light up:

- The output voltage does not reach  $\pm 30$  V of the set test-voltage.
- During the test, the output voltage deviates from test-voltage and does not return to  $\pm 30$  V of the set value within 5 seconds.

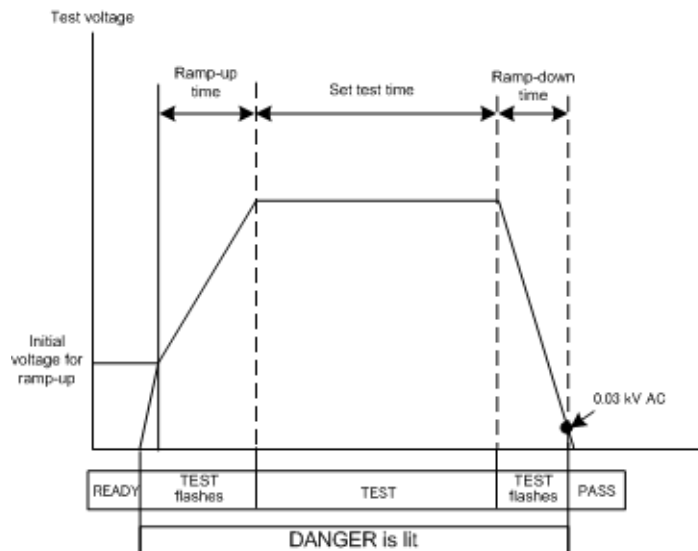

### 3.4.1 "PASS" Determination

Test is successful when **PASS** lights up.

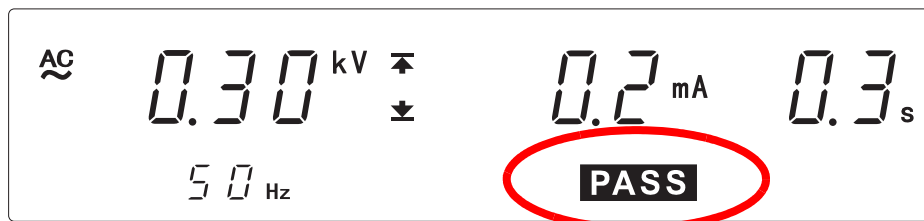

3

In the initial setting, **PASS** will light up for about 0.3 seconds before returning to READY mode.



To hold the **PASS** display  
See "6.2.1 PASS Hold" (p. 85)

When test time is set, **PASS** will appear when the test has completed. If the ramp-down time is set, the reduction timer starts counting down the ramp-down time. Upon expiration of the time, the measurement result upon completion of the test is displayed, and the instrument changes to the PASS state. In the PASS state, **PASS** is lit.

### 3.4.2 "FAIL" Determination

Test is unsuccessful when **FAIL** lights up. **FAIL** display will be retained. (default condition)

**NOTE**

When a current 1.5 times higher than the upper-limit test value is flowing while performing a withstand-voltage test, the voltage is immediately blocked by the insulation circuit, resulting in an UPPER FAIL. In such cases, the measured current value is not displayed correctly. The current value is not displayed, and " - - - " will appear.

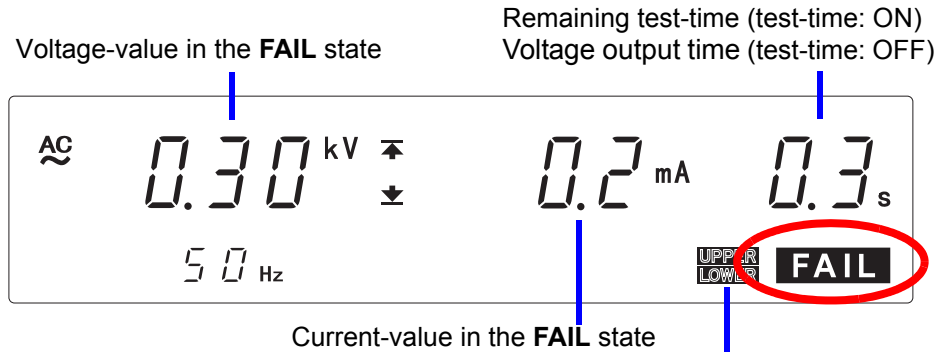

- UPPER FAIL** Indicates current measurement value higher than the upper-limit test value
- LOWER FAIL** Indicates current measurement value lower than the lower-limit test value
- UPPER LOWER FAIL** Indicates test abnormalities such as the output voltage not reaching the set voltage.

To return to the READY state, press the **STOP** key, which will cancel the FAIL Hold function.

To delete the held value shown when the test ended in FAIL. See "6.2.2 FAIL Hold" (p. 86)

In normal tests, it takes about 100 ms for the instrument to detect FAIL until the output voltage is OFF.

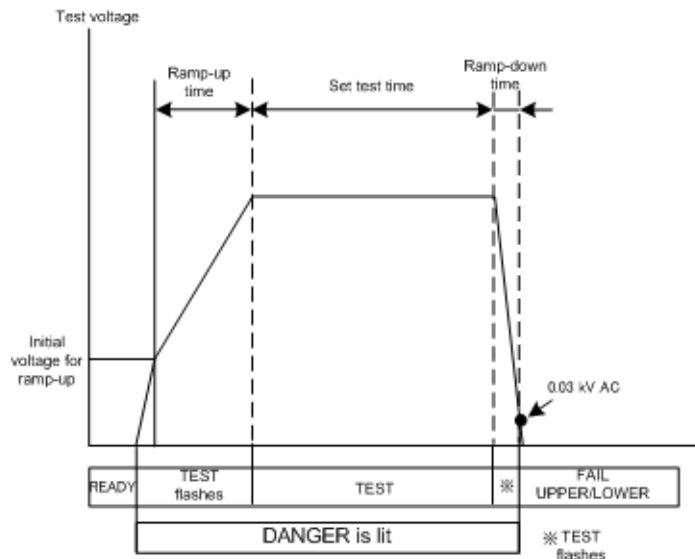

# Insulation-Resistance Test Chapter 4

This chapter describes how to set insulation-resistance test conditions and the proper testing procedure. Read "Chapter 2 Testing Arrangements" (p. 17), and make the necessary preparations for testing.

Refer to "Chapter 5 Automatic Test" (p. 69) for carrying out withstanding and insulation-resistance tests consecutively.

4

## **! DANGER**

To prevent electric shock, when the **DANGER** lamp is lit or during the test, never touch the voltage output terminals, test lead, or the tested object.

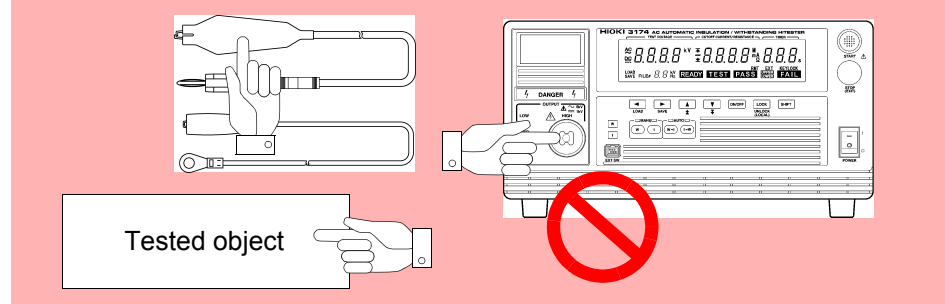

## **! WARNING**

- To prevent electric shocks, do not connect to or remove the test lead from the tested object when there is a voltage supply during the test. There is a danger of a voltage higher than the pre-set voltage being supplied due to the stabilization function of the voltage output. When this happens, the instrument may malfunction due to the noise produced.
- The instrument and peripheral electrical devices may not function properly when the tested object's insulation is broken or when the test leads are not connected properly. When this happens, connect a ferrite core or a resistor to the test lead on the high voltage side. Be careful of a dip in the test voltage caused by the rated power, withstanding voltage and resistor when choosing a resistor.
- Wear insulated gloves and confirm that automatic control is off before changing the tested object or touching the test lead and tested object directly.
- To increase test efficiency, this instrument can be controlled by EXT I/O or RS-232C and GP-IB and can start tests automatically. As a result, there is a danger of electric shock accidents. Measures to prevent people from coming near the instrument or the tested object unintentionally must be taken when starting the instrument automatically.

## **! CAUTION**

- When the tested object in use possesses an inductivity like a coil, a voltage higher than the pre-set voltage may appear transitionally, causing damage in the tested object.

## Select the insulation-resistance test mode

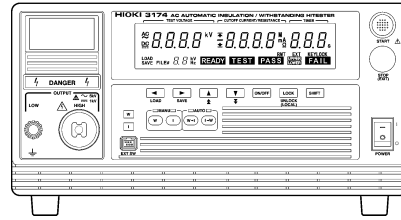
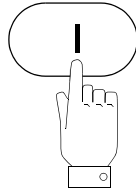

## Set test conditions

"4.1.1 Setting the Test-Voltage Value" (p. 50)

"4.1.2 Setting the Upper (Lower) Limit Value" (p. 51)

"4.1.3 Setting the Test Time Timer" (p. 53)

"4.1.4 Setting the Delay Time" (p. 54)

## Starting a test

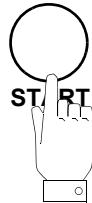

Press the **START** key to start a test. (p. 57)

## Displaying the test result

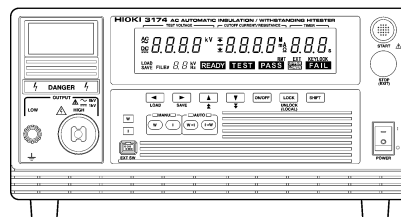

**PASS**

Test result (p. 59)

## 4.1 Setting the Test Conditions

For safety reasons, be sure to carry out pre-test check (p. 26) before setting the test conditions.

Setting the test conditions.

Pre-set the insulation-resistance test termination mode for the optional functions.

See "6.7 Insulation-Resistance Test Termination Mode" (p. 92)

Pre-set test conditions can be retrieved to carry out the test.

See "7.2 Loading the Test Conditions" (p. 102)

### Test setting state

When **READY** lights up on the screen, pressing the ◀ / ▶ key will change the status to the test conditions status. The test voltage will flash (**READY** will go off). Set the test conditions in this status.

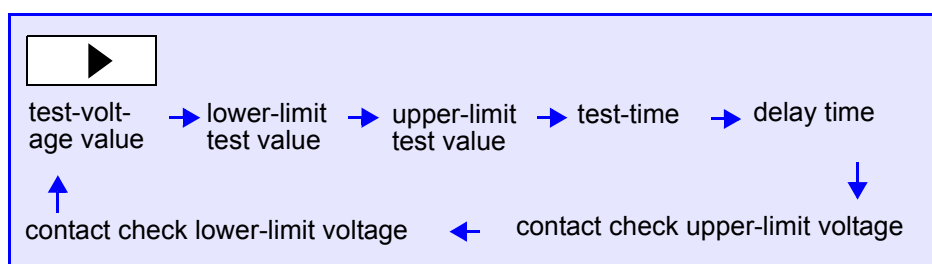
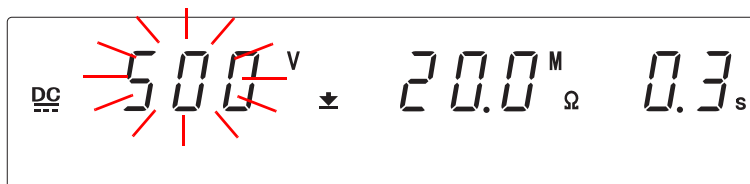

If the item is not needed in the test, set it to OFF using the **ON/OFF** key. However, the test-voltage value and the lower-limit test value cannot be set to OFF. Pre-set test conditions can be saved.

See "7.1 Saving the Test Conditions" (p. 99)

### NOTE

- In the test setting state, the test cannot start. Test will only start when **READY** lights up.
- Indicates the voltage for the output terminal in Test-voltage value in **READY** and test status.
- When **READY** lights up,  $\overline{\text{READY}}$  for EXT I/O turns Lo at the same time.

### 4.1.1 Setting the Test-Voltage Value

Set a test-voltage value. When the test is started, the pre-set voltage will be supplied to the tested object from the voltage output terminal via the test lead. Select from 500 V and 1000 V.

The test will not start if the load is large and the output voltage does not reach a level higher than the set test-voltage. (**TEST** flashes.)

If the output voltage deviates from test-voltage and does not return to a level higher than the set voltage-value within 5 seconds, the test is terminated.

1.



When **READY** is lit on the screen, press the **▶** key to get to the test conditions mode.

\* **READY** will not be displayed during the Double Action setting.

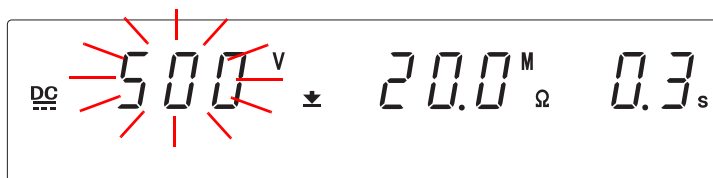

2.



or



Press the **▲** / **▼** keys to set the test-voltage value.

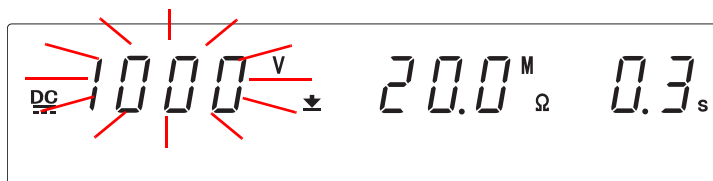

<Ex.> Set to 1000 V.

Set voltage: 500 V / 1000 V

3.



Press the **STOP** key to complete the setting value.  
The instrument reverts to the **READY** state.

To continue to the setting for the next item, press the **▶** key.

#### **NOTE**

- The tested object may damage if a voltage higher than necessary is supplied. Be careful when setting the output voltage to ensure that the tested object does not receive a voltage higher than necessary.
- The tested object may damage if a voltage is supplied longer than necessary. Be careful when setting the test time.
- When the tested object faces a capacity load, the output voltage may become higher than the pre-set voltage (set the pre-set voltage 1.2 times lower under a capacity load of more than 5  $\mu$ F)
- The output voltage may increase if a spark discharge occurs, for example due to faulty measurement target insulation or incomplete discrete contact. If the measurement voltage exceeds 600 V (with a test voltage of 500 V) or 1,200 V (with a test voltage of 1,000 V), an **UPPER** / **LOWER** / **FAIL** FAIL judgment will result, and testing will stop.



## 4.1.2 Setting the Upper (Lower) Limit Value

Set a upper-limit test value and a lower-limit test value. For example, when the lower-limit (upper-limit) test value is set to 100 M $\Omega$ , a "PASS" will show if the measurement resistance value is more than (or below) 100 M $\Omega$ . If no upper-limit test value is required, set it to "OFF" using the ON/OFF key. However, the lower-limit test value cannot be set to OFF.

1.



Press the ► key to move the flashing cursor to the lower-limit test value.

2.



Press the ▲ / ▼ keys to set the lower-limit test value.

Refer to the next page for the Setting Resolution.

or

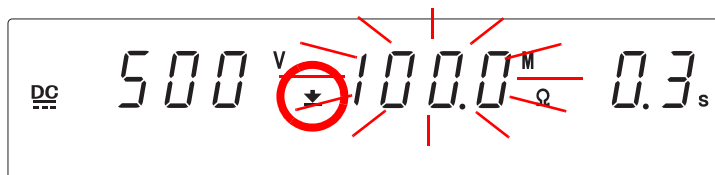

<Ex.> Set to 100 M $\Omega$ .

Guaranteed accuracy range: 0.5 M $\Omega$  to 2000 M $\Omega$

Press ▲ / ▼ keys while holding down the SHIFT key, the value increases or decreases 10 times more rapidly than when the SHIFT key is not held down.

3.



Press the ► key to move the flashing cursor to the upper-limit test value.

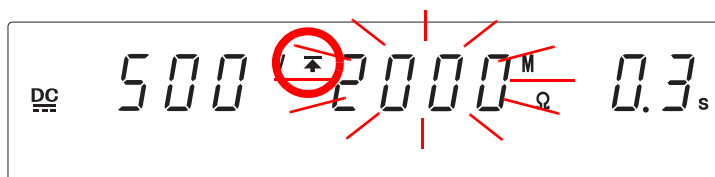

<Ex.> Set to 2000 M $\Omega$ .

4.



Press the ▲ / ▼ keys to set the upper-limit test value.

Guaranteed accuracy range: 0.5 M $\Omega$  to 2000 M $\Omega$

or



If no upper-limit test value is required, set it to "OFF" using the ON/OFF key.

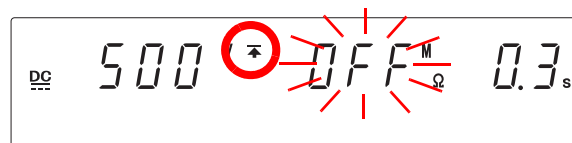

<Ex.> Set to OFF.

5.



STOP

Press the STOP key to complete the setting value.

The instrument reverts to the READY state.

To continue to the setting for the next item, press the ► key.

**NOTE**

- If the set lower-limit test value is greater than the upper-limit test value, unable to get out of setting screen. In such a case, correct the upper- or lower-limit test value.
- A upper-limit test value is not necessary in the insulation-resistance test but pre-setting it will allow the instrument to be used for simple Contact Checks.

**Upper- or lower-value and Resolution**

Setting range (MΩ)	Setting resolution (MΩ)
0.20 to 2.00	0.01
2.10 to 20.0	0.1
21.0 to 200	1
210 to 2000	10

**Relationship between test voltage, lower-limit test values and ranges, measurement ranges**

Test voltage (V)	Lower-limit test values (MΩ)	Ranges	Measurement ranges (MΩ)
500	0.20 to 2.00	2 MΩ	0.17 to 10.0 <sup>*1</sup>
	2.10 to 20.0	20 MΩ	1.70 to 100
	21.0 to 200	200 MΩ	17.0 to 1000
	210 to 2000	2000 MΩ	170 to 2200 <sup>*2</sup>
1000	1.00 to 4.00	4 MΩ	0.50 to 20.0 <sup>*3</sup>
	4.10 to 40.0	40 MΩ	3.40 to 200
	41.0 to 400	400 MΩ	34.0 to 2000
	410 to 2000	2000 MΩ	340 to 2200 <sup>*2</sup>

\*1: 0.17 to 0.49 Outside confirmed range

\*2: 2001 to 2200 Outside confirmed range

\*3: 0.50 to 0.99 Outside confirmed range

**NOTE**

- When the resistance value exceeds the measurement range, it is displayed as "**O.F.**" (overflow).
- When the set resistance value does not reach the measurement range, values are displayed on the "**U.F.**" (underflow).
- You can make the resistance measurement range a fixed range or an auto-range.  
See "6.8 Auto-range for insulation-resistance test" (p. 95)
- In fixed range measurements, the upper and lower limit values that can be set in the respective ranges are the values of the measurement ranges within the reliable guaranteed range for each of the range.  
When it is not possible to get out of the setting screen, the upper-limit value and the lower-limit value may be out of the ranges shown above. Confirm the setting value.

### 4.1.3 Setting the Test Time Timer

When the test time timer is set, the test will automatically run and stop when the time is up. If no test-time timer is required, set it to "OFF" using the **ON/OFF** key.

1.



Press the ► key to move the flashing cursor to the test-time timer.

2.



or



Press the ▲ / ▼ keys to set the test-time timer.



<Ex.> Set to 0.3 s.

Setting range: 0.3 to 999 s

- When the set time scale is 0.3 s to 99.9 s  
The value changes by 0.1 s. To change the value by 1 s, while holding down the **SHIFT** key, press ▲ / ▼ keys.
- When the set time scale is 100 s to 999 s  
The value changes by 1 s. To change the value by 10 s, while holding down the **SHIFT** key, press ▲ / ▼ keys.

If no test-time timer is required, set it to "OFF" using the **ON/OFF** key.



<Ex.> Set to OFF.

3.



STOP

Press the **STOP** key to complete the setting value.  
The instrument reverts to the READY state.

To continue to the setting for the next item, press the ► key.

#### **NOTE**

- Screening is not conducted for insulation-resistance tests when the test time timer is set to OFF. However, if "Evaluate even for forced termination of test" (p. 88) for an optional function is set, evaluation will be carried out when test is forcibly terminated. Also, the time elapsed during the test is displayed. When this time exceeds 999 s, "- - -" will appear, but the test will continue.
- If a test-time timer has been set, the reduction timer will operate during the test.
- When Auto Range is set (see "6.8 Auto-range for insulation-resistance test" (p. 95)), it takes approximately 1.5 s for the range to stabilize after the test starts. When the set test time is shorter than this, test may end in **UPPER LOWER FAIL**.
- If the test time is short, the output voltage may not reach the preset test voltage, depending on the tested object.
- When testing a tested object which includes some capacity properties, set the delay time and test time after factoring in the charging time by using the "Insulation-Resistance Test Termination Mode" (p. 92).

## 4.1.4 Setting the Delay Time

Time during which screening is not performed from the start of a test (delay time) can be set. This is effective when a tested object contains a capacity component.

1.



Press the ► key to move the flashing cursor to the test-time timer.

2.



Press the ► key again to display the delay time setting screen.

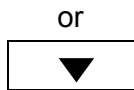

<Ex.> Set to 0.1 s.

Setting range: 0.1 to 99.9 s (The value changes by 0.1 s.)

To change the value by 1 s, while holding down the **SHIFT** key, press ▲ / ▼ keys.

If no delay time is required, set it to "OFF" using the **ON/OFF** key.

3.



Press the **STOP** key to complete the setting value.

The instrument reverts to the READY state.

To continue to the setting for the next item, press the ► key.

### NOTE

- After the delay time is set, if it is turned OFF and turned ON again using the **ON/OFF** key, the delay time returns to the value set before OFF.
- Screening is not conducted for insulation-resistance tests when the test time timer is set to OFF. However, if "Evaluate even for forced termination of test" (p. 88) for an optional function is set, evaluation will be carried out when test is forcibly terminated.
- When some capacity properties are included to the tested object, it may take time for the measurement value to be stabilized. Set the delay time appropriately to allow the ample time for the measurement value to stabilize.

## 4.1.5 Setting the Confirmation Voltage used for upper and lower-limits for Contact Check

Confirmation Voltage used for upper and lower-limits for Contact Check  
Contact Check can be carried out by measuring the terminal voltage of the tested object. When this function is pre-set, test abnormalities can be detected whenever the output voltage deviates from the pre-set ranges. The setting for the upper or lower limit voltage confirmation is the same as that used for the H side terminal Contact Check, but setting either the upper limit or the lower limit will also automatically allow for Contact Checks on the L side terminals.

By measuring the voltage on the H side terminals of the tested object, checks on whether an accurate voltage is supplied to the test terminals or not (whether the test lead is properly connected or not: Contact Check) can be carried out. When a value outside the range of the pre-set terminal voltage is achieved, an error number will show and the test will terminate.

When Contact Check Function is not in use, press the **ON/OFF** key to set to "OFF".

1.



Press the ► key to move the flashing cursor to the upper-limit confirmation voltage for Contact Check.

2.

When measuring the insulation-resistance, the following values will automatically be set when the upper-limit Contact Check voltage is set to ON.

Test-voltage 500 V : Upper-limit voltage 600 V

Test-voltage 1000 V : Upper-limit voltage 1200 V

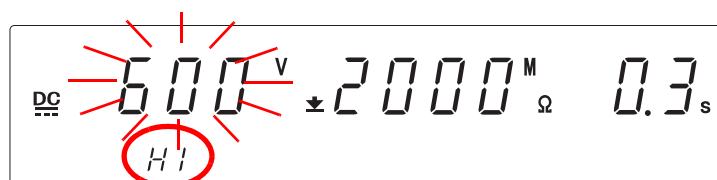

If no upper-limit confirmation voltage for Contact Check is required, set it to "OFF" using the **ON/OFF** key.

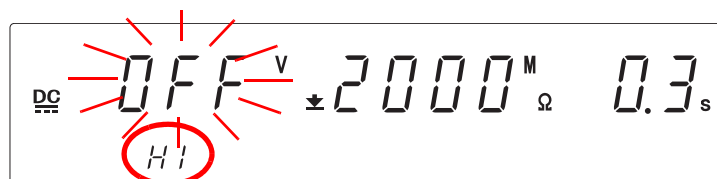

#### 4.1 Setting the Test Conditions

3.



Press the **▶** key to move the flashing cursor to the lower-limit confirmation voltage for Contact Check.

4.

When measuring the insulation-resistance, the following values will automatically be set when the lower-limit Contact Check voltage is set to ON.

Test-voltage 500 V : Lower-limit voltage 500 V

Test-voltage 1000 V: Lower-limit voltage 1000 V

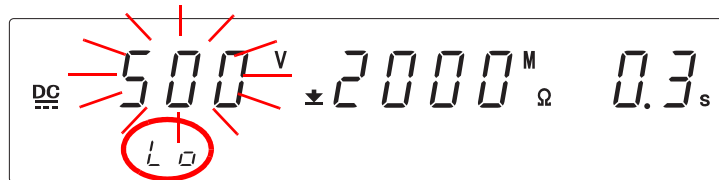

If no lower-limit confirmation voltage for Contact Check is required, set it to "OFF" using the **ON/OFF** key.



5.



Press the **STOP** key to complete the setting value.  
The instrument reverts to the READY state.

To continue to the setting for the next item, press the **▶** key.

#### NOTE

When contact error is detected, the following errors will be displayed and the test will terminate.

- Err4** Contact error at the L side terminal
- Err6** Output measurement voltage lower than the lower-limit confirmation voltage (output abnormality)
- Err7** Contact voltage lower than the lower-limit confirmation voltage (measurement-type malfunction, contact error)
- Err9** Output voltage higher than the upper-limit confirmation voltage (output-type or measurement-type malfunction)

\* When FAIL hold is not set, an error message will appear for about 0.5 seconds before returning to READY mode.

## 4.2 Starting a Test

Carry out the test after finishing setting the test conditions (p. 49).  
For safety reasons, key lock is recommended. All keys except the **START** key and **STOP** key are disabled while the key-lock function is active.(p. 79)



To prevent electric shock, check the following before starting test.

Front panel

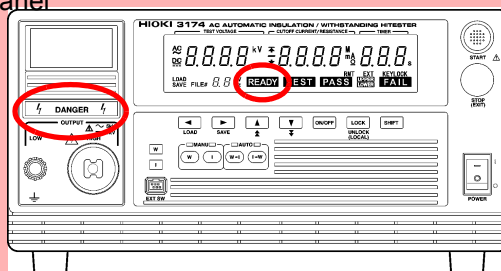

- The **DANGER** lamp is OFF.
- The **READY** lamp is lit (it is off in the Double Action mode).

4



After measuring the insulation-resistance for a tested object which has some capacity properties, the capacitor of the tested object may become charged. The instrument will make use of the electrical discharge function to show a **DANGER** warning signal until the safety voltage is reached, but if the electricity is not discharged properly, it may cause electrical shocks or damages to other instruments.



- If a capacity load is applied to the tested object, the output voltage may exceed the preset voltage, thereby damaging the equipment.
- Continuous output of a high voltage may heat the bottom of the instrument. To prevent from getting scalded, do not touch the bottom.

### NOTE

- There is a priority hierarchy for the **START** keys.  
Priority hierarchy: Remote Control Box > EXT I/O > Front panel of the 3174 (3174-01)  
Note that when a **START** key with a higher priority is in use, lower-priority keys are disabled.
- When measuring the insulation-resistance for a tested object which has some capacity properties, the output voltage may dip because some current is used to charge the capacitor, resulting in inaccurate measurement of the insulation-resistance value. Carry out the test (PASS, FAIL) only when the output voltage is stable and the delay time has been set.

1. Double action state **READY** will not be displayed because the default factory setting for this instrument is Double Action.

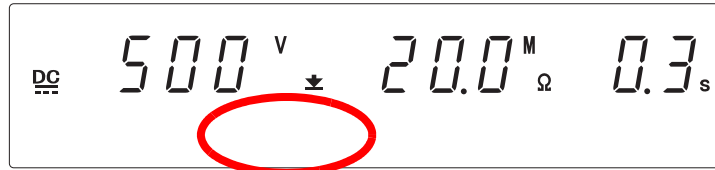

**READY** is not lit.

2.



Press the **STOP** key once in the beginning.

When the **STOP** key is pressed, **READY** will be shown for 0.5 seconds.



3.

(**READY** is lit)



To start the test, press the **START** key when **READY** is shown.  
The **DANGER** lamp on the front panel of instrument is lit.

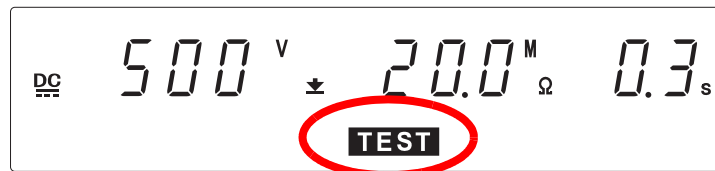

- **TEST** flashing on screen : Output voltage rising.
- **TEST** lit up on screen : Output voltage has reached the test voltage. Test starts.
- **To forcibly terminate the test, press the STOP key.**  
The instrument will immediately stop outputting a voltage and switch to the **READY** state.



If the **DANGER** lamp does not go off even after the test has finished, this could mean that some voltage stronger than the safe voltage (about 30 V AC or 60 V DC) still remains in the voltage output terminal. To prevent electric shock, never touch the voltage output terminals.



Test does not start

When lower-limit test value  $\geq$  upper-limit test value, unable to get out of setting screen.

When the test time is not set, a test judgment will not appear. To forcibly terminate the test, press the **STOP** key. A test judgement will not be carried out when the test is forcibly terminated, but it is still possible to do so with the optional function setting.

See "6.3 Evaluate even for forced termination of test" (p. 88)



## 4.3 Terminate the Test

When the test-time is set

Test will automatically stop when the test is carried out during the pre-set test time.

Front panel

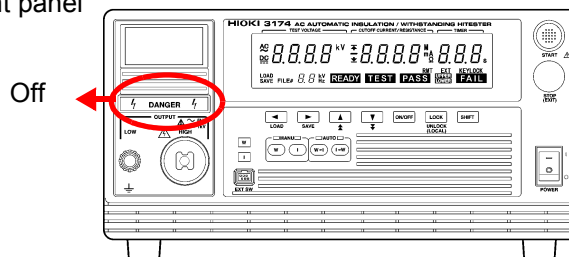

When the test-time has not been set

Press the **STOP** key to terminate the test.

Front panel

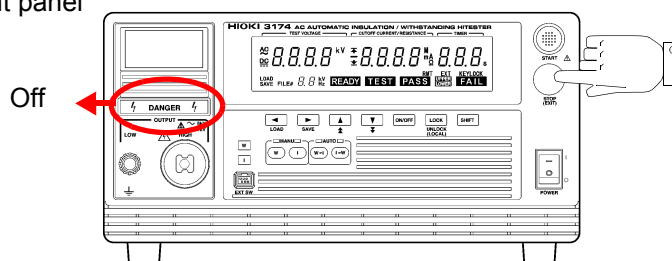

Forcibly terminate

Pressing the **STOP** key during the test will forcibly stop the test.



Test forcibly stopped when **UPPER** / **LOWER** **FAIL** judgment is shown (**UPPER** **LOWER** **FAIL** all light up)

- During the test, if the output voltage deviates from test-voltage and does not return to the set value within 5 seconds.
- If the output voltage does not reach the set test-voltage.
- When a spark discharge occurs, causing the measurement voltage to exceed 600 V (with a test voltage of 500 V) or 1,200 V (with a test voltage of 1,000 V).

### **UPPER** **FAIL** or **LOWER** **FAIL**

- When the test time timer is activated, and a resistance measurement value higher or lower than the upper and lower-limits test values is reached during testing when "FAIL Completion" is set.
- When the test time timer is activated, and time continues to pass when a resistance measurement value higher or lower than the upper and lower-limits test values is reached even when "Timer Completion" is set.
- When the test time timer is activated and "PASS Completion" is set, duration of test time in the case when the resistance measurement value is beyond the upper or lower limit values.

To show test results even when test is forcibly terminated.

See "6.3 Evaluate even for forced termination of test" (p. 88)

To hold the value shown when test is forcibly terminated.

See "6.2.3 STOP Hold" (p. 87)

## Automatic discharge function



This instrument is equipped with a function to discharge residual electricity upon termination of the insulation-resistance test (discharge resistance: 800 k $\Omega$ ).

Never touch the voltage output terminals, test lead, or the tested object until the **DANGER** lamp goes out.

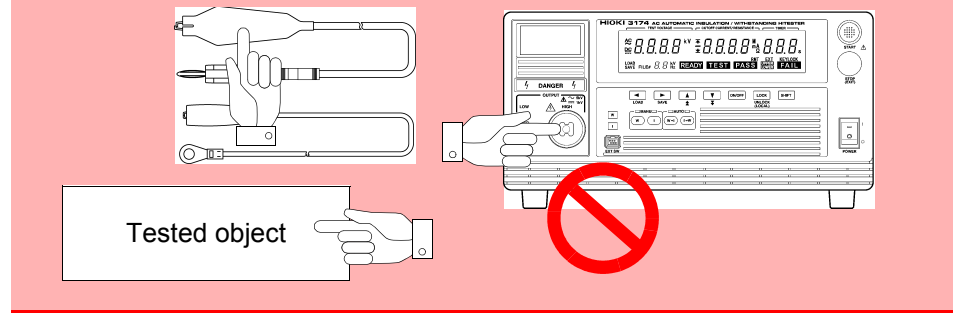

When a test object that contains a capacity component is subjected to a test, the object might remain electrically charged, thereby causing an electric shock.

The instrument automatically switches to the internal discharge circuit to discharge the test object (the **DANGER** lamp is lit). When the voltage between the output terminals falls below the safety voltage (approximately 60 V DC), the **DANGER** lamp goes out. The larger the capacity component of the test object, the more time is required to discharge the test object.

### NOTE

- The instrument does not return to the READY state until the **DANGER** lamp goes out upon completion of the test. Until the instrument returns to the READY state, no key operation is accepted.
- With an optional setting, the instrument can change to the READY state, regardless of the **DANGER** lamp indication, upon completion of the test.

See "6.1.4 START Protection" (p. 82)

In such a case, the voltage output terminals may contain residual electricity even when the instrument is in the READY state.

## 4.4 Displaying the Test Result



Even following a test, there may be a residual voltage at the output terminal. Therefore, to prevent electric shock, check the following before touching the output-voltage terminal, test lead, or tested object, make sure that no high voltage is being applied between the output terminals.

Front panel

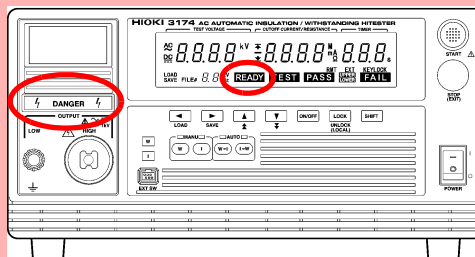

- The **DANGER** lamp is OFF.
- The **READY** lamp is lit (it is off in the Double Action mode).

4

The test result is displayed on the screen. "PASS" or "FAIL" screening is conducted according to the insulation-resistance test termination mode settings based on whether a measured-resistance value exceeded the upper- or lower-limit value.

Display	Test result
<b>PASS</b> is lit	<b>PASS</b> will appear when the resistance measurement value is lower than the upper-limit test value and higher than the lower-limit test value.
<b>FAIL</b> is lit	<b>FAIL</b> will appear when the resistance measurement value is higher than the upper-limit test value or lower than the lower-limit test value.

If the output voltage fails to reach the test voltage within approximately 5 seconds after the **START** key is pressed, the instrument returns a UPPER/LOWER FAIL result.

In the following cases, tests are terminated, and **UPPER**, **LOWER**, and **FAIL** light up:

- If the output voltage does not reach the set test-voltage.
- During the test, if the output voltage deviates from test-voltage and does not return to the set value within 5 seconds.

### 4.4.1 "PASS" Determination

Test is successful when **PASS** lights up. Under the settings in the insulation-resistance test termination mode, when the resistance measurement value is higher than the lower-limit test value, and lower than the upper-limit test value, a **PASS** will show and the voltage output will stop.

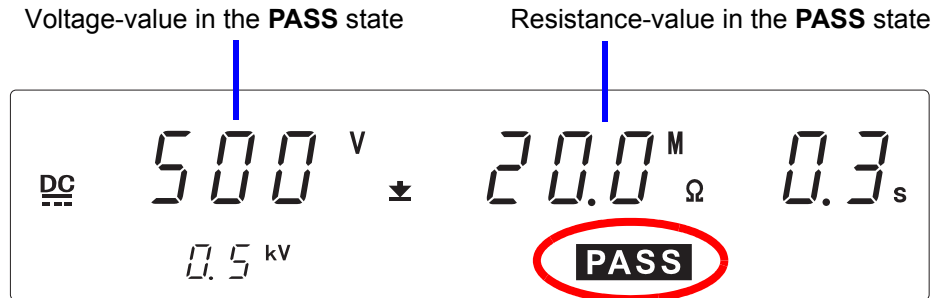

In the initial setting, **PASS** will light up for about 0.3 seconds before returning to READY mode.



To hold the **PASS** display  
 See "6.2.1 PASS Hold" (p. 85)

See "6.7 Insulation-Resistance Test Termination Mode" (p. 92)

**Installation** Flow of PASS determination  
 (Timer stops: See "6.7 Insulation-Resistance Test Termination Mode" (p. 92))

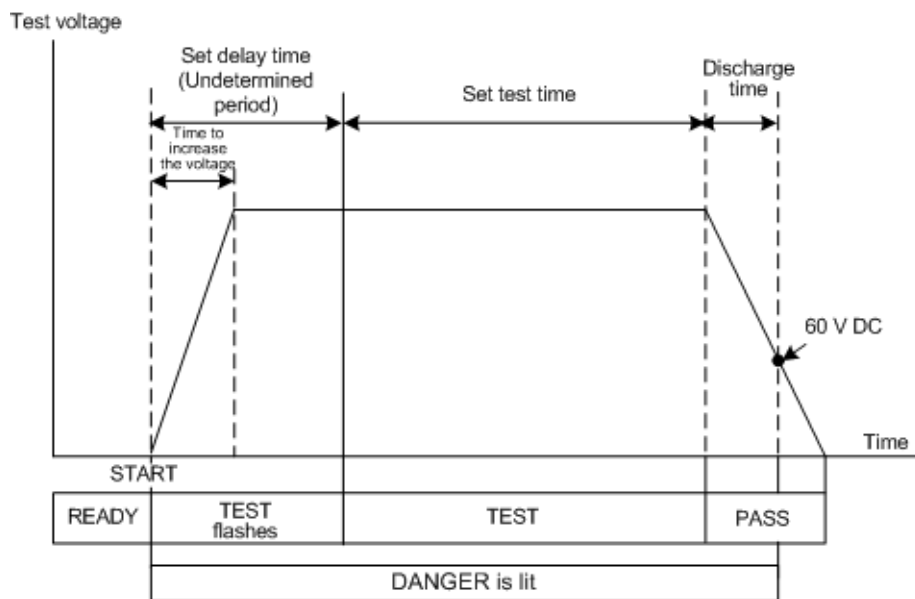

## 4.4.2 "FAIL" Determination

Test is unsuccessful when **FAIL** lights up. **FAIL** display will be retained. (default condition)

The instrument switches to the FAIL state and stops outputting a voltage if the measured resistance value deviates from the upper or lower-limit test value.

Voltage-value in the **FAIL** state

Resistance-value in the **FAIL** state



<b>UPPER</b>	<b>FAIL</b>	Indicates resistance measurement value higher than the upper-limit test value
<b>LOWER</b>	<b>FAIL</b>	Indicates resistance measurement value lower than the lower-limit test value
<b>UPPER</b> <b>LOWER</b>	<b>FAIL</b>	Indicates test abnormalities such as the output voltage not reaching the set voltage.

When the FAIL status is retained, to return to the READY state, press the **STOP** key, which will cancel the FAIL Hold function. In normal tests, the time from when the instrument achieves and detects a FAIL evaluation to the time when the output voltage becomes OFF depends on the size of the capacity property of the tested object.



To delete the held value shown when the test ended in FAIL.  
See "6.2.2 FAIL Hold" (p. 86)

See "6.7 Insulation-Resistance Test Termination Mode" (p. 92)

**Installation** Flow of FAIL determination  
 (Timer stops: See "6.7 Insulation-Resistance Test Termination Mode" (p. 92))

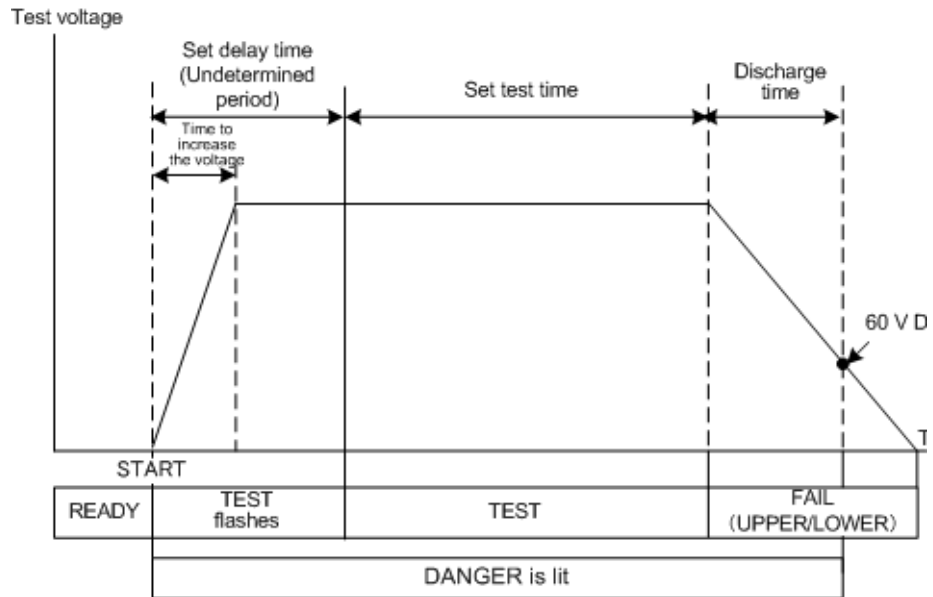

### NOTE

- When the optional "Insulation-Resistance Measurement Range" function is set to "1: Auto Range", it takes up to 1.5 s to display the resistance value. When the test finishes before the preset test time, test may end in **UPPER LOWER FAIL**.
- When a fixed range is set, "O.F." will show when the value is beyond the range's measurements and "U.F." will show when the value is lower than the measurement range.
- During Auto Range evaluation "O.F.", "U.F." will be shown when the instrument's measurement ranges are exceeded.

### 4.4.3 Influence of capacity on the test result (reference data)

#### ◆ Test conditions

Test mode : Insulation-resistance test mode (Retrieve 100 s worth of data every 0.1 s in RS-232C Communication)

Load : DECADE RESISTANCE BOX DR15510

Capacity load : 0.5  $\mu$ F, 1.0  $\mu$ F, 2.0  $\mu$ F

Range : 2000 M-range (1000 V / 500 V)  
400 M, 40 M, 4 M-range (1000 V)  
200 M, 20 M, 2 M-range (500 V)

Note: The instrument specifications are specifications for the forward resistance loads.

The following fluctuations may occur when measuring the capacity loads.

#### ◆ 2000 M-range (output voltage: 1000 V)

Resistance value (M $\Omega$ )	Capacitance					
	0.5 $\mu$ F		1 $\mu$ F		2 $\mu$ F	
	Minimum value (M $\Omega$ )	Maximum value (M $\Omega$ )	Minimum value (M $\Omega$ )	Maximum value (M $\Omega$ )	Minimum value (M $\Omega$ )	Maximum value (M $\Omega$ )
2200	2175	2199 (O.F.)	2154	2199 (O.F.)	2097	2199 (O.F.)
2100	2086	2116	2057	2124	2025	2160
2000	1987	2015	1966	2019	1918	2043
1900	1883	1905	1863	1908	1829	1920
1800	1789	1811	1766	1815	1745	1826
1700	1688	1710	1679	1723	1639	1729
1600	1591	1607	1568	1612	1551	1612
1500	1492	1506	1480	1508	1457	1522
1400	1393	1406	1384	1408	1359	1412
1300	1292	1307	1287	1310	1270	1317
1200	1194	1299	1185	1207	1172	1210
1100	1095	1103	1090	1106	1080	1201
1000	996	1003	989	1003	976	1005
900	895	901	889	900	883	906
350	349	350	348	350	347	350

\* 2001 M to 2200 M: Outside confirmed range

#### ◆ 2000 M-range (output voltage: 500 V)

Resistance value (M $\Omega$ )	Capacitance					
	0.5 $\mu$ F		1 $\mu$ F		2 $\mu$ F	
	Minimum value (M $\Omega$ )	Maximum value (M $\Omega$ )	Minimum value (M $\Omega$ )	Maximum value (M $\Omega$ )	Minimum value (M $\Omega$ )	Maximum value (M $\Omega$ )
2000	1955	1985	1940	1999	1926	2023
1900	1857	1891	1844	1898	1818	1912
1800	1768	1787	1757	1793	1729	1814
1700	1677	1689	1661	1699	1635	1711
1600	1571	1590	1561	1595	1538	1605
1500	1477	1494	1466	1499	1454	1518
1400	1379	1394	1372	1398	1354	1409
1000	990	996	987	998	981	1004
900	890	898	887	898	881	903
800	792	799	791	799	784	801
180	178.8	179.1	178.7	179.1	179.1	180

## ◆ 400 M-range

Resistance value (MΩ)	Capacitance					
	0.5 μF		1 μF		2 μF	
	Minimum value (MΩ)	Maximum value (MΩ)	Minimum value (MΩ)	Maximum value (MΩ)	Minimum value (MΩ)	Maximum value (MΩ)
2000	1941	1983 (O.F.)	1901 (U.F.)	1981 (O.F.)	1829 (U.F.)	1981 (O.F.)
1900	1795	1905	1760	1866	1760	1981
1800	1697	1793	1729	1829	1671	1831
1700	1639	1699	1639	1699	1558	1761
1600	1533	1585	1509	1698	1486	1697
1500	1378	1486	1419	1486	1398	1535
1400	1359	1401	1340	1399	1303	1420
1000	971	991	971	1013	952	1002
900	880	906	880	906	865	906
800	786	799	779	799	773	807
700	689	700	684	705	684	705
35	34.9		34.7	34.9	34.8	34.9

\* Colored portion: outside scope of reliability.

## ◆ 200 M-range

Resistance value (MΩ)	Capacitance					
	0.5 μF		1 μF		2 μF	
	Minimum value (MΩ)	Maximum value (MΩ)	Minimum value (MΩ)	Maximum value (MΩ)	Minimum value (MΩ)	Maximum value (MΩ)
1000	956	996	975	995	936(U.F.)	995
900	868	885	868	901	852	901
800	770	810	770	796	770	796
700	673	692	673	702	673	702
600	582	597	582	597	575	597
500	487	497	487	497	482	497
400	—	—	391	397	388	398
22	21.9		21.9		21.9	

\* Colored portion: outside scope of reliability.

## ◆ 40 M-range

Resistance value (MΩ)	Capacitance					
	0.5 μF		1 μF		2 μF	
	Minimum value (MΩ)	Maximum value (MΩ)	Minimum value (MΩ)	Maximum value (MΩ)	Minimum value (MΩ)	Maximum value (MΩ)
200	190.5	197.9	190.5	197.9	190.5	197.9
190	183.7	190.7	180.5	187.1	180.5	187.1
180	171.5	177.5	171.5	180.7	177.3	180.7
170	163.1	165.9	166.0	171.6	166.0	171.6
160	156.0	161.0	155.9	160.9	153.4	160.9
150	144.9	151.4	144.9	151.4	147.1	151.4
130	126.8	130.3	125.4	128.6	126.8	128.6
3.5	3.48		3.48		3.48	

\* Colored portion: outside scope of reliability.



 20 M-range

Resistance value (MΩ)	Capacitance					
	0.5 μF		1 μF		2 μF	
	Minimum value (MΩ)	Maximum value (MΩ)	Minimum value (MΩ)	Maximum value (MΩ)	Minimum value (MΩ)	Maximum value (MΩ)
100	95.6	99.3	97.6	99.5 (O.F.)	97.4	99.4 (O.F.)
90	87.6	89.2	87.5	89.1	87.5	90.7
80	78.3	82.1	77.0	80.7	77.1	80.8
70	67.0	68.9	68.9	69.9	67.1	69.9
60	58.6	60.0	59.4	60.1	59.4	60.1
50	49.2	49.7	49.2	49.7	48.7	49.2
1.8	1.79		1.79		1.79	

\* Colored portion: outside scope of reliability.

4

 4 M-range

Resistance value (MΩ)	Capacitance					
	0.5 μF		1 μF		2 μF	
	Minimum value (MΩ)	Maximum value (MΩ)	Minimum value (MΩ)	Maximum value (MΩ)	Minimum value (MΩ)	Maximum value (MΩ)
20	19.91	19.92	19.54	19.92	19.14	19.89
19	18.47	19.16	18.80	19.18	18.46	19.16
18	17.87	17.94	17.86	17.90	17.52	18.16
17	16.88	16.95	16.88	16.95	16.41	16.68
16	15.87	15.91	15.91	15.94	15.43	16.17
12	11.91	11.95	11.91	11.95	11.89	12.05
1	1.00		1.00		1.00	

\* Colored portion: outside scope of reliability.

 2 M-range

Resistance value (MΩ)	Capacitance					
	0.5 μF		1 μF		2 μF	
	Minimum value (MΩ)	Maximum value (MΩ)	Minimum value (MΩ)	Maximum value (MΩ)	Minimum value (MΩ)	Maximum value (MΩ)
10	9.80	10.00	9.80	10.00 (O.F.)	9.80	10.00 (O.F.)
9	8.81	8.96	8.65	9.12	8.65	9.11
8	7.87	8.12	7.75	7.87	7.75	8.12
7	6.93	7.02	6.74	6.92	6.74	6.92
6	5.97	6.04	5.97	6.04	5.90	6.04
2	1.99	2.00	1.99	2.00	1.99	2.00
0.5	0.50		0.50		0.50	

\* Colored portion: outside scope of reliability.



# Automatic Test

# Chapter 5

In the continuous test, withstand-voltage and insulation-resistance tests are conducted successively. Read "Chapter 3 Withstand-Voltage Test" (p. 29) and "Chapter 4 Insulation-Resistance Test" (p. 47), and set the test conditions.

## Set each test condition

Withstand-voltage test "3.1 Setting the Test-Conditions" (p. 31)

insulation-resistance test "4.1 Setting the Test Conditions" (p. 49)

5

## Select the test mode

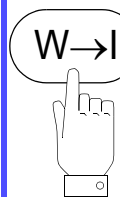

Withstand-voltage test  
↓  
Insulation-resistance test

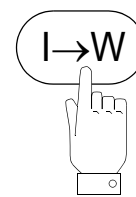

Insulation-resistance test  
↓  
Withstand-voltage test

## Starting a test



Press the **START** key to start a test. (p. 71)

## Displaying the test result

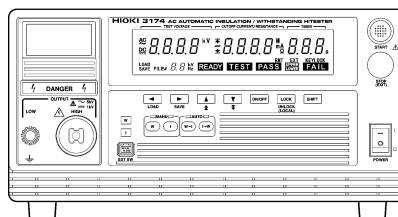

**PASS**

Test result (p. 73)

## 5.1 Setting the Test Conditions

For safety reasons, be sure to carry out pre-test check (p. 26) before setting the test conditions.

Setting the test conditions.

To set or change the test conditions, do so in the test setting mode for the respective withstanding and insulation-resistance tests.

Withstand-voltage test : "3.1 Setting the Test-Conditions" (p. 31)

Insulation-resistance test : "4.1 Setting the Test Conditions" (p. 49)

### **NOTE**

- If the test time is set to **OFF** in the withstand-voltage mode or insulation-resistance mode, the test mode with its time set to **OFF** is displayed (**OFF** flashes) upon startup of the test in the Auto test mode, and the test cannot be started. Return to withstand-voltage or insulation-resistance mode, and set the test time to **ON**.
- When setting for the current or resistance value is set at lower-limit test value  $\geq$  upper-limit test value, each value will flash when the test starts and the setting screen will freeze, making it impossible to get out.
- If the test-voltage value is greater than the output-voltage restricting value, unable to get out of setting screen.

See "6.1.5 Output-Voltage Restricting" (p. 83)

---

## 5.2 Starting a Test

Carry out the test after finishing setting the test conditions.

For safety reasons, key lock is recommended. All keys except the **START** key and **STOP** key are disabled while the key-lock function is active.(p. 79)



To prevent electric shock, check the following before starting test.

Front panel

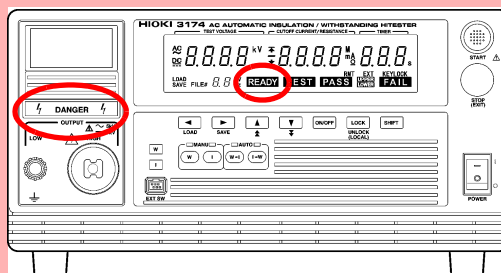

- The **DANGER** lamp is OFF.
- The **READY** lamp is lit (it is off in the Double Action mode).

5



- If a capacity load is applied to the tested object, the output voltage may exceed the preset voltage, thereby damaging the equipment.
- Continuous output of a high voltage may heat the bottom of the instrument. To prevent from getting scalded, do not touch the bottom.

### NOTE

There is a priority hierarchy for the **START** keys.

Priority hierarchy: Remote Control Box > EXT I/O > Front panel of the 3174 (3174-01)

Note that when a **START** key with a higher priority is in use, lower-priority keys are disabled.

1. Double action state **READY** will not be displayed because the default factory setting for this instrument is Double Action.

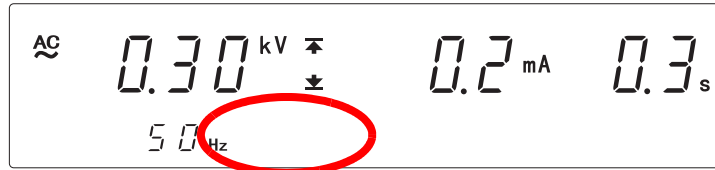

2.



**READY** is not lit.  
Press the **STOP** key once in the beginning.  
When the **STOP** key is pressed, **READY** will be shown for 0.5 seconds.

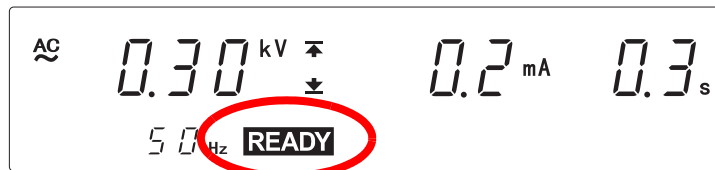

3.

(READY is lit)



To start the test, press the **START** key when **READY** is shown.  
The **DANGER** lamp on the front panel of instrument is lit.

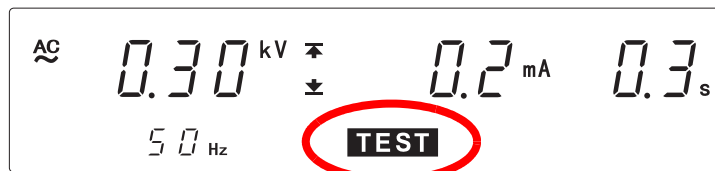

In W → I mode, the test order is Withstand-voltage test → Insulation-resistance test.

In I → W mode, the test order is Insulation-resistance test → Withstand-voltage test.

- To forcibly terminate the test, press the **STOP** key.  
The instrument will immediately stop outputting a voltage and switch to the **READY** state.



If the **DANGER** lamp does not go off even after the test has finished, this could mean that some voltage stronger than the safe voltage (about AC 30 V or DC 60 V) still remains in the voltage output terminal. To prevent electric shock, never touch the voltage output terminals.



Test does not start

- When lower-limit test value  $\geq$  upper-limit test value, each value will flash when the test starts and the setting screen will freeze, making it impossible to get out.
- When the output-voltage restricting value (optional function) < test voltage value, unable to get out of setting screen.

See "6.1.5 Output-Voltage Restricting" (p. 83)

To set the upper-limit test voltage for safety reasons  
(initial setting at 5.00 kV)

See "6.1.5 Output-Voltage Restricting" (p. 83)

## 5.3 Terminate the Test

Automatically stops when the withstanding test and insulation-resistance test stop.

Front panel

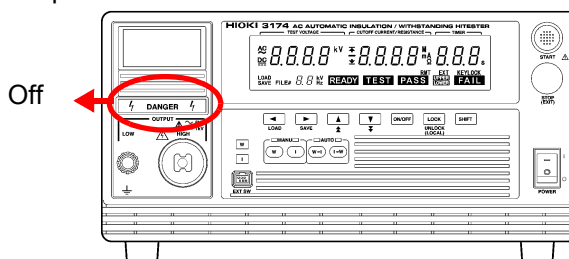

Forcibly terminate

Press the **STOP** key to terminate the test.

5



Test forcibly stopped when **UPPER** / **LOWER** **FAIL** judgment is shown (**UPPER** **LOWER** **FAIL** all light up)

In the withstand-voltage test:

- During the test, if the output voltage deviates from test-voltage and does not return to  $\pm 30$  V of the set value within 5 seconds.
- If the test voltage does not reach  $\pm 30$  V of the set test-voltage.

In the insulation-resistance test:

- During the test, if the output voltage deviates from test-voltage and does not return to the set value within 5 seconds.
- If the test-voltage does not reach the set test-voltage.
- When a spark discharge occurs, causing the measurement voltage to exceed 600 V (with a test voltage of 500 V) or 1,200 V (with a test voltage of 1,000 V).

**UPPER** **FAIL** or **LOWER** **FAIL**

- In the withstand-voltage test, if the measured-current value exceeds the upper- or lower-limit test value during the test-time.
- In the insulation-resistance test, when the test time timer is activated, and a resistance measurement value higher or lower than the upper and lower-limits test values is reached during testing when "FAIL Completion" is set.
- In the insulation-resistance test, when the test time timer is activated, and time continues to pass when a resistance measurement value higher or lower than the upper and lower-limits test values is reached even when "Timer Completion" is set.
- In the insulation-resistance test, when the test time timer is activated and "PASS Completion" is set, duration of test time in the case when the resistance measurement value is beyond the upper or lower limit values.

To hold the value shown when test is forcibly terminated.

See "6.2.3 STOP Hold" (p. 87)

During consecutive testing, a test judgment in a forced termination cannot be carried out.

## Automatic discharge function



This instrument is equipped with a function to discharge residual electricity upon termination of the insulation-resistance test (discharge resistance: 800 k $\Omega$ ).

Never touch the voltage output terminals, test lead, or the tested object until the **DANGER** lamp goes out.

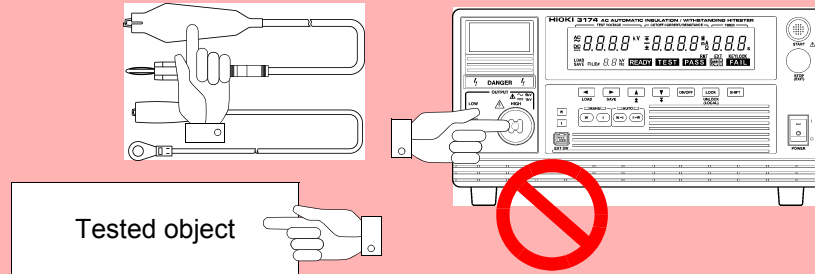

When a test object that contains a capacity component is subjected to a test, the object might remain electrically charged, thereby causing an electric shock. The instrument automatically switches to the internal discharge circuit to discharge the test object (the **DANGER** lamp is lit). When the voltage between the output terminals falls below the safety voltage (approximately 30 V AC or 60 V DC), the **DANGER** lamp goes out. The larger the capacity component of the test object, the more time is required to discharge the test object.

### NOTE

- In W  $\rightarrow$  I mode, the insulation-resistance test does not start up if the voltage between the output terminals has not fallen below the safety voltage (approximately 30 V AC) upon completion of the withstand-voltage test.
- In I  $\rightarrow$  W mode, the withstand-voltage test does not start until the voltage between the output terminals has fallen below the safety voltage (approximately 60 V DC) upon completion of the insulation-resistance test.
- The instrument does not return to the READY state until the **DANGER** lamp goes out upon completion of the test. Until the instrument returns to the READY state, no key operation is accepted.
- With an optional setting, the instrument can change to the READY state, regardless of the **DANGER** lamp indication, upon completion of the test.

See "6.1.4 START Protection" (p. 82)

In such a case, the voltage output terminals may contain residual electricity even when the instrument is in the READY state.



## 5.4 Displaying the Test Result



Even following a test, there may be a residual voltage at the output terminal. Therefore, to prevent electric shock, check the following before touching the output-voltage terminal, test lead, or tested object, make sure that no high voltage is being applied between the output terminals.

Front panel

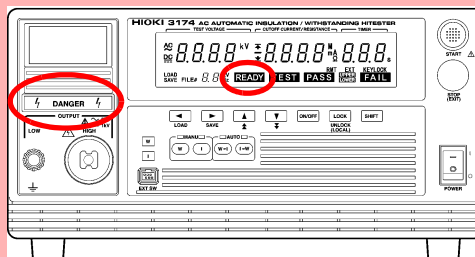

- The **DANGER** lamp is OFF.
- The **READY** lamp is lit (it is off in the Double Action mode).

5

Display	Test result
<b>PASS</b> is lit	Both the withstand-voltage and insulation-resistance tests were passed.
<b>FAIL</b> is lit	Either the withstand-voltage or insulation-resistance test was failed.

In the following cases, tests are terminated, and **UPPER**, **LOWER**, and **FAIL** light up:

In the withstand-voltage test:

- During the test, the output voltage deviates from test-voltage and does not return to  $\pm 30$  V of the set value within 5 seconds.
- If the test-voltage does not reach  $\pm 30$  V of the set test-voltage.

In the insulation-resistance test:

- During the test, if the output voltage deviates from test-voltage and does not return to the set value within 5 seconds.
- If the test-voltage does not reach the set test-voltage.
- When a spark discharge occurs, causing the measurement voltage to exceed 600 V (with a test voltage of 500 V) or 1,200 V (with a test voltage of 1,000 V).

When PASS hold and FAIL hold for optional functions are set, pressing the **W** key or the **I** key when the test has stopped enables the respective test results to be confirmed. Tests results for tests not carried out cannot be confirmed then.

See "6.2.1 PASS Hold" (p. 85)

See "6.2.2 FAIL Hold" (p. 86)

If the first test shows FAIL in the automatic test mode, the next test will not be carried out.

### 5.4.1 "PASS" Determination

Test is successful when **PASS** lights up.

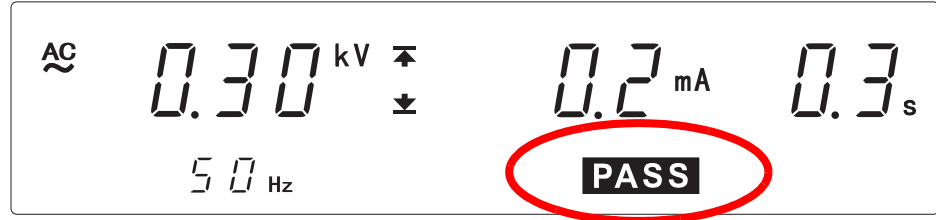

**PASS** will light up for about 0.3 seconds before returning to READY mode.



To hold the **PASS** display  
See "6.2.1 PASS Hold" (p. 85)

A **PASS** will be shown when both the withstanding and insulation-resistance tests pass upon completion of the tests.

If the ramp-down time is set, the reduction timer starts counting down the ramp-down time. Upon expiration of the time, the measurement result upon completion of the test is displayed, and the instrument changes to the **PASS** state. In the **PASS** state, **PASS** is lit.

Flow of PASS determination

W → I

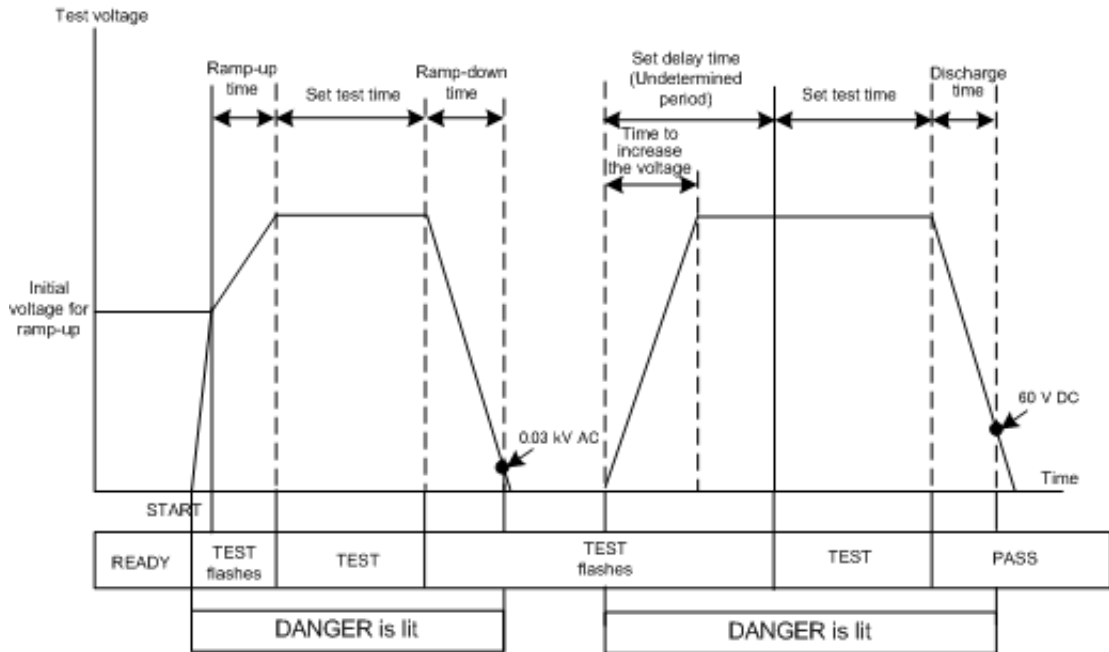

5

I → W

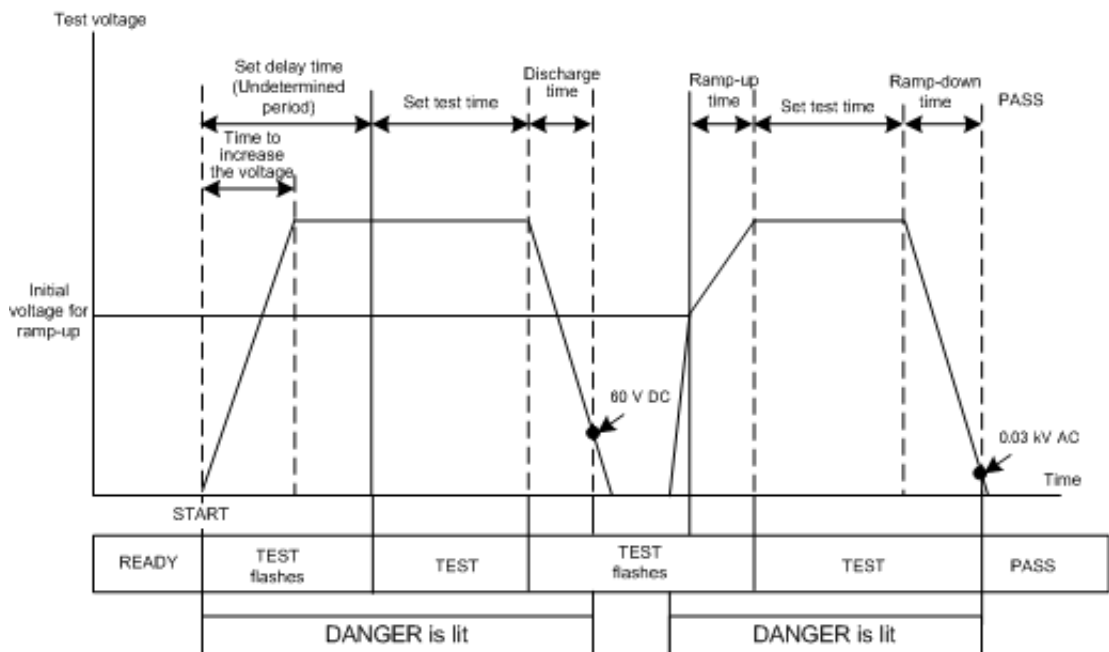

## 5.4.2 "FAIL" Determination

Test is unsuccessful when **FAIL** lights up. Similar to the withstand-voltage test or insulation-resistance test FAIL state.

Withstand-voltage test : "3.4.2 "FAIL" Determination" (p. 46)

Insulation-resistance test : "4.4.2 "FAIL" Determination" (p. 63)

### **NOTE**

- When a current 1.5 times higher than the upper-limit test value is flowing while performing a withstand-voltage test, the voltage is immediately blocked by the insulation circuit, resulting in an UPPER FAIL. In such cases, the current value is not displayed, and " - - " will appear.
  - When the optional "Insulation-Resistance Measurement Range" function is set to "1: Auto Range", it takes up to 1.5 s to display the resistance value. When the insulation-resistance test finishes before the preset test time, test may end in **UPPER LOWER FAIL**.
  - When a fixed range is set, "O.F." will show when the value is beyond the range's measurements and "U.F." will show when the value is lower than the measurement range.
-

# Useful Functions Chapter 6

## 6.1 Functions for carrying out the tests safely

### 6.1.1 Key-lock Function

It inactivates all keys except the **START** key and **STOP** key.  
The **KEYLOCK** lamp is lit while the key-lock function is active. Use this function when you do not want to change the test mode or test settings.

#### NOTE

Even when the key-lock function is activated, the **START** and **STOP** keys on the remote control box and the signals on the external I/O terminal remain active.

#### Key-lock

LOCK

To switch to the KEY-LOCK state, press the **LOCK** key.

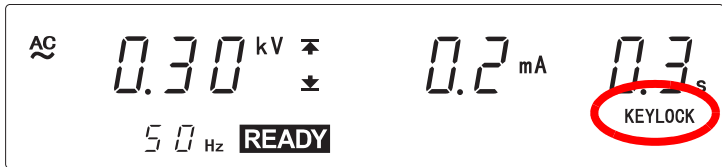

All keys except the **START** key and **STOP** key are disabled.

#### Canceling the key-lock

SHIFT

+

LOCK

To cancel the key-lock, press the **LOCK** key while holding down the **SHIFT** key.

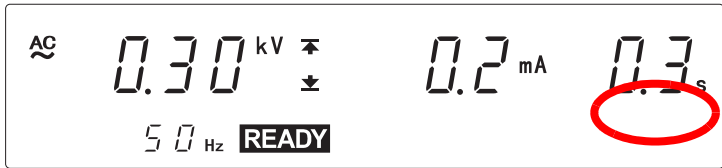

## 6.1.2 Momentary Out

See "Appendix2 List of Optional Functions" (p. A4)

The momentary out function allows the test only while the **START** key is held down. Releasing the **START** key is equivalent to pressing the **STOP** key and ends the test.

To perform PASS/FAIL screening, hold down the **START** key until the preset test time elapses. During the "6.3 Evaluate even for forced termination of test" (p. 88) setting, evaluation will take place when the **START** key is released.

The **START** key on the remote control box or the START signal via external I/O has the same effect.

1. (**READY** is lit)

Make sure the **READY** lamp is lit on the screen.

\* **READY** will not be displayed during the Double Action setting.

2.

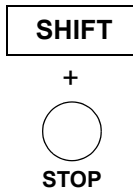

Press the **STOP** key while holding down the **SHIFT** key to display the optional screen (page 1).



3.



Press the **▶** key to move the flashing cursor to the position of momentary out.

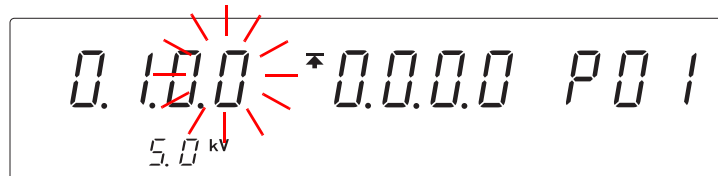

4.

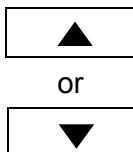

Press the **▲ / ▼** keys to select the mode.



<Ex.> Momentary out is set to ON.

**0**: Momentary out is OFF (Initial setting)

**1**: Momentary out is ON

5.

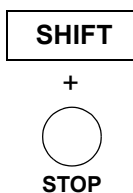

Press the **STOP** key while holding down the **SHIFT** key to complete the setting value.

The instrument reverts to the READY state.

To continue to the setting for the next item, press the **▶** key.

**NOTE**

There is a priority hierarchy for the **START** keys.

Priority hierarchy: Remote Control Box > EXT I/O > Front panel of the 3174 (3174-01)

## 6.1.3 Double Action

See "Appendix2 List of Optional Functions" (p. A4)

Functions to prevent mishandling and to carry out the tests safely.

The test starts if the **START** key is pressed within approximately 0.5 s of the **STOP** key being pressed. Normally, pressing the **START** key only starts the test. However, when using the double action function, the **STOP** key must be pressed before pressing the **START** key. This function increases testing safety by preventing operational errors.

**READY** only lights up for approximately 0.5 seconds after the **STOP** key is pressed.

1. **READY** is lit)

Make sure the **READY** lamp is lit on the screen.

\* **READY** will not be displayed during the Double Action setting.

2.

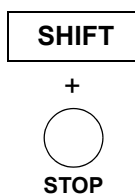

Press the **STOP** key while holding down the **SHIFT** key to display the optional screen (page 1).



3.



Press the **▶** key to move the flashing cursor to the position of double action.



4.

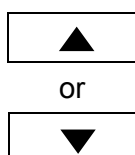

Press the **▲** / **▼** keys to select the mode.

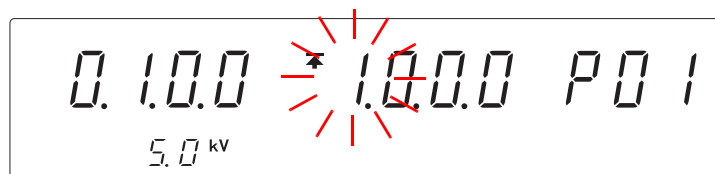

<Ex.> Double action is set to ON.

0: Double action is OFF

1: Double action is ON (Initial setting)

5.

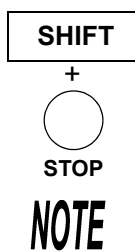

Press the **STOP** key while holding down the **SHIFT** key to complete the setting value.

The instrument reverts to the READY state.

To continue to the setting for the next item, press the **▶** key.

- The double action function can be set in combination with the momentary out function. If settings are made in this way, press the **START** key within 0.5 seconds after the **STOP** key is pressed to start a test. Hold down the **START** key during the test.
- When STOP hold and Double Action are set simultaneously, the display during STOP hold will be the same as the display for Double Action. First, press the **STOP** key once to release hold, then start using the Double Action function.
- The double-action setting is not valid for START commands from RS-232C or GP-IB.

## 6.1.4 START Protection

See "Appendix2 List of Optional Functions" (p. A4)

This is a function for preventing the instrument from starting the next test during discharge time upon completion of each withstand-voltage or insulation-resistance test.

1. (READY is lit)

Make sure the **READY** lamp is lit on the screen.

\* **READY** will not be displayed during the Double Action setting.

2.

SHIFT

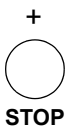

Press the **STOP** key while holding down the **SHIFT** key to display the optional screen (page 1).



3.



Press the **▶** key to move the flashing cursor to the position of page, and then press the **▲ / ▼** keys to display the optional screen (page 2).

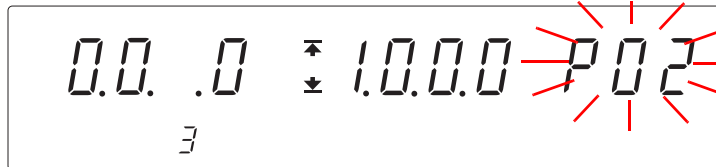

4.



Press the **▶** key to move the flashing cursor to the position of START protection.

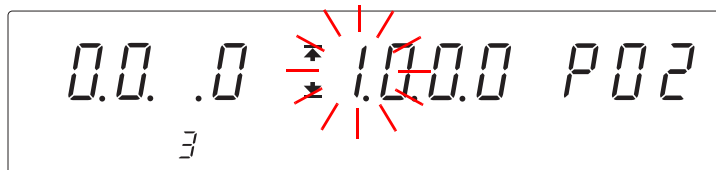

5.



or



Press the **▲ / ▼** keys to select the mode.

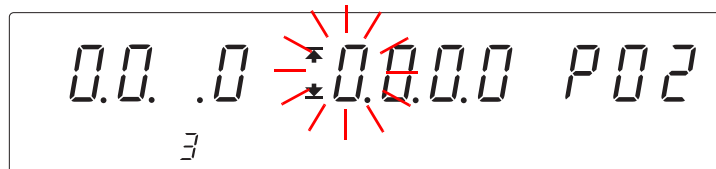

<Ex.> START protection is set to OFF.

0: START protection is OFF

1: START protection is ON (Initial setting)

6.

SHIFT

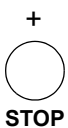

Press the **STOP** key while holding down the **SHIFT** key to complete the setting value.

The instrument reverts to the READY state.

To continue to the setting for the next item, press the **▶** key.

**NOTE**

- If the START protection function is used for tests that are to be performed successively, such as tests in auto-test mode, the instrument does not proceed to the next test until completion of discharge, as the discharging function is enabled upon termination of each test (in the meantime, no key operation is accepted).
- Note that if "0: OFF" is selected, even when the instrument is in READY state upon completion of the test, residual electricity may remain between the output terminals.
- During automatic test mode, protection kicks in and START for electricity discharge will not be accepted.



## 6.1.5 Output-Voltage Restricting

See "Appendix2 List of Optional Functions" (p. A4)

Enable this function to set the upper-limit for the voltage to be output by this instrument.

Set the value in the range of 0.2 kV to 5.0 kV (in 0.1-kV steps, effective value). Only available for withstanding test.

When the factory default is set to 5.0 kV.

1. (READY is lit)

Make sure the **READY** lamp is lit on the screen.

\* **READY** will not be displayed during the Double Action setting.

2.

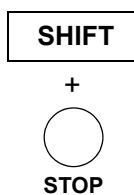

Press the **STOP** key while holding down the **SHIFT** key to display the optional screen (page 1).



3.



Press the **▶** key to move the flashing cursor to the position of output-voltage restricting.



4.

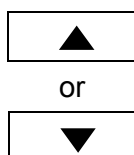

Press the **▲** / **▼** keys to select the mode.



<Ex.> Set to 3 kV.

Setting range: 0.2 to 5.0 kV (The value changes by 0.1 kV.)  
(Initial setting: 5.0 kV)

5.

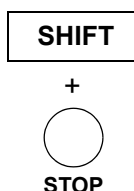

Press the **STOP** key while holding down the **SHIFT** key to complete the setting value.

The instrument reverts to the READY state.

To continue to the setting for the next item, press the **▶** key.

### NOTE

- If the set test voltage is greater than the voltage value set here, an error will occur upon startup of the test (the test-voltage value flashes), and it will not be possible to conduct the test.
- If the test-voltage value that is loaded by loading a set value is greater than the set upper-limit, an error will occur upon startup of the test (the test-voltage value flashes), and it will not be possible to conduct the test.

## 6.2 Display Hold (Hold Function)

There are 3 types of functions, PASS Hold, FAIL hold, STOP hold, to hold the display.

Distinction between the PASS Hold, FAIL Hold, and STOP Hold

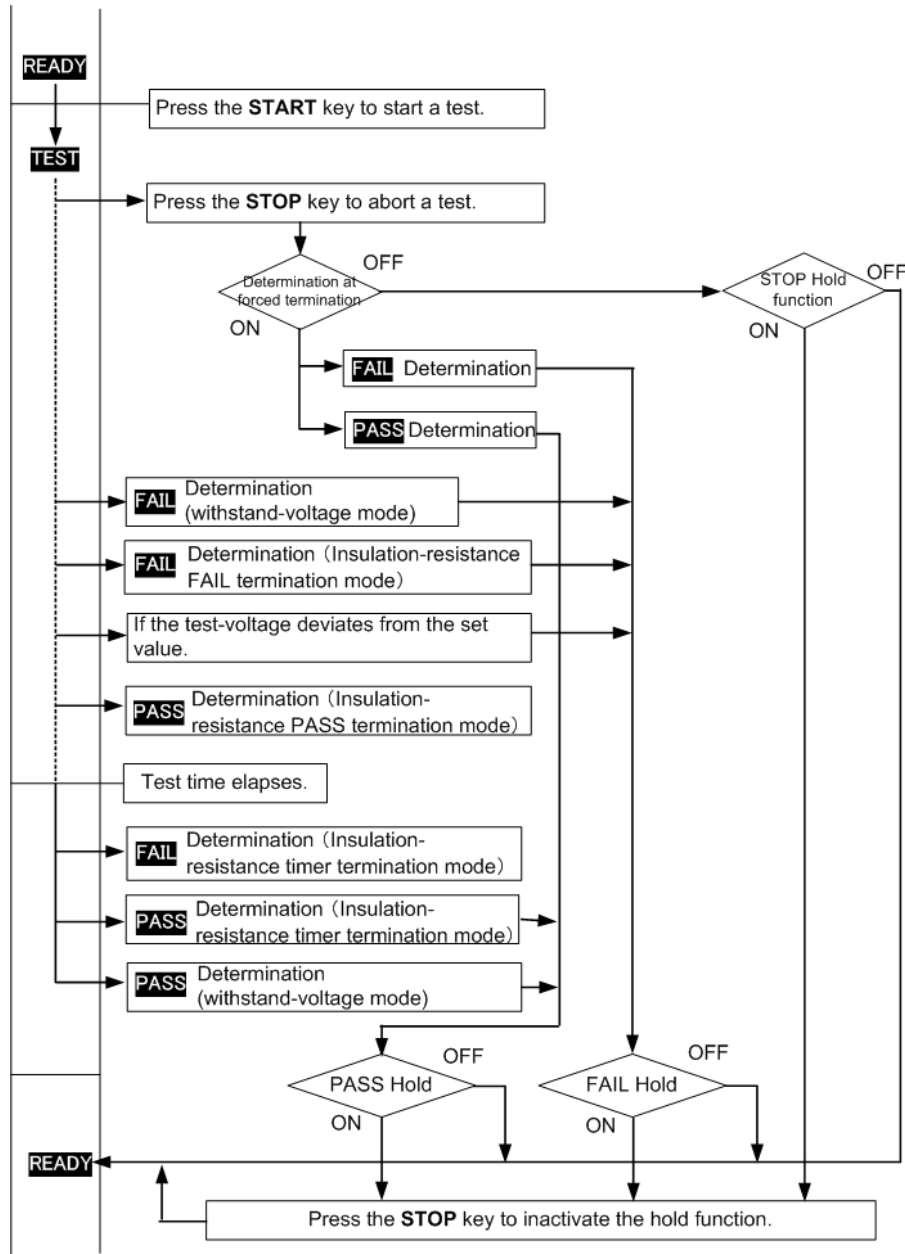

### NOTE

- If the test time is set to OFF in withstand-voltage mode, PASS screening is not performed. In such a case, FAIL screening is performed or the test is terminated using the **STOP** key.
- In insulation-resistance mode, if the test time is set to OFF, PASS screening is not performed. In such a case, the test is terminated using the **STOP** key.
- Even when the test time is set to OFF during the withstanding and insulation-resistance tests, setting the instrument to the "6.3 Evaluate even for forced termination of test" (p. 88) setting and pressing the **STOP** key will enable the instrument to evaluate PASS or FAIL at the end of the test.  
(A FAIL evaluation for the withstand-voltage test is acquired when FAIL is shown.)

## 6.2.1 PASS Hold

See "Appendix2 List of Optional Functions" (p. A4)

Retains the value shown when the test has ended and **PASS** is displayed. To return to the READY state, press the **STOP** key, which will cancel the Hold. When the PASS hold function is disabled, the test result is displayed for 0.3 seconds, and the instrument reverts to the READY state.

1. (READY is lit)

Make sure the **READY** lamp is lit on the screen.

\* **READY** will not be displayed during the Double Action setting.

2.

SHIFT

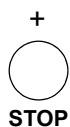

Press the **STOP** key while holding down the **SHIFT** key to display the optional screen (page 1).



3.



or



Press the ▲ / ▼ keys to select the setting PASS hold.



<Ex.> Select PASS hold.

0: PASS hold is not used (Initial setting)

1: PASS hold is used

4.

SHIFT

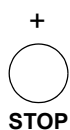

Press the **STOP** key while holding down the **SHIFT** key to complete the setting value.

The instrument reverts to the READY state.

To continue to the setting for the next item, press the ► key.

## 6.2.2 FAIL Hold

See "Appendix2 List of Optional Functions" (p. A4)

Retains the value shown when the test has ended and **FAIL** is displayed. To return to the READY state, press the **STOP** key, which will cancel the Hold. When the FAIL hold function is disabled, the test result is displayed for 0.3 seconds, and the instrument reverts to the READY state.

See "6.5 Limiting the FAIL Hold Cancellation (FAIL mode)" (p. 90)

1. (**READY** is lit)

Make sure the **READY** lamp is lit on the screen.

\* **READY** will not be displayed during the Double Action setting.

2.

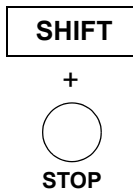

Press the **STOP** key while holding down the **SHIFT** key to display the optional screen (page 1).



3.



Press the **▶** key to move the flashing cursor to the position of FAIL hold.



4.

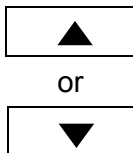

Press the **▲** / **▼** keys to select the mode.



<Ex.> Select Without FAIL hold.

**0**: FAIL hold is not used

**1**: FAIL hold is used (Initial setting)

5.

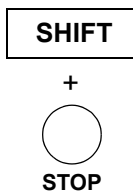

Press the **STOP** key while holding down the **SHIFT** key to complete the setting value.

The instrument reverts to the READY state.

To continue to the setting for the next item, press the **▶** key.

## 6.2.3 STOP Hold

See "Appendix2 List of Optional Functions" (p. A4)

Retains the value when the test has been forcibly terminated by pressing the **STOP** key during the test. To return to the READY state, press the **STOP** key, which will cancel the Hold.

If the Hold function is not selected, the instrument switches to the READY state upon forced termination of the test.

When the "Evaluate even for forced termination of test" is set for the optional function, this setting will be ignored.

1. (READY is lit)

Make sure the **READY** lamp is lit on the screen.

\* **READY** will not be displayed during the Double Action setting.

2.

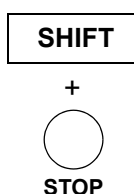

Press the **STOP** key while holding down the **SHIFT** key to display the optional screen (page 1).



3.



Press the **▶** key to move the flashing cursor to the position of STOP hold.



4.

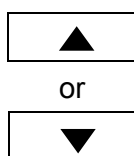

Press the **▲ / ▼** keys to select the mode.

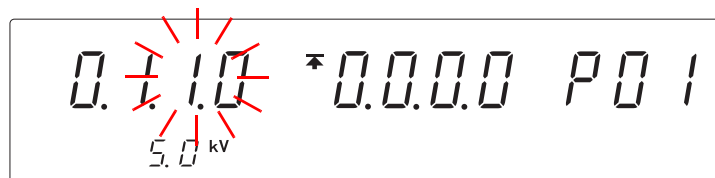

<Ex.> Select STOP hold.

**0**: STOP hold is not used (Initial setting)

**1**: STOP hold is used

5.

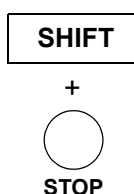

Press the **STOP** key while holding down the **SHIFT** key to complete the setting value.

The instrument reverts to the READY state.

To continue to the setting for the next item, press the **▶** key.

## 6.3 Evaluate even for forced termination of test

See "Appendix2 List of Optional Functions" (p. A4)



Under normal circumstances, the test result will not be shown when the test is forcibly terminated. However, setting this function will allow for the test result to be shown even when the test has been forcibly terminated.

1. (READY is lit)

Make sure the **READY** lamp is lit on the screen.

\* **READY** will not be displayed during the Double Action setting.

2. 

Press the  key to move the flashing cursor to the position of page, and then press the  /  keys to display the optional screen (page 2).



3. 

Press the  key to move the flashing cursor to the position of judgment when test has been forcibly terminated.

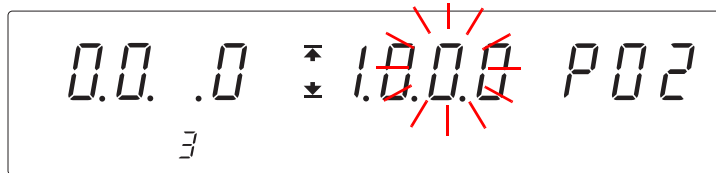

4. 

Press the  /  keys to select the mode.

or  

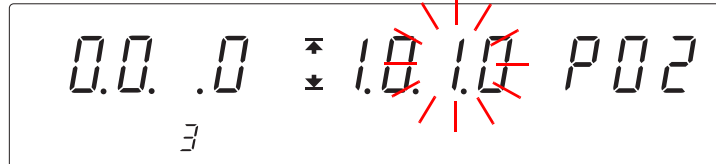

<Ex.> Select ON for evaluation in a forced termination.

- 0: evaluation in a forced termination OFF  
(No evaluation during a forced termination) (Initial setting)
- 1: evaluation in a forced termination ON  
(Evaluate even during forced termination)

5. 

Press the **STOP** key while holding down the **SHIFT** key to complete the setting value.

+



STOP

The instrument reverts to the READY state.

To continue to the setting for the next item, press the  key.

**NOTE**

- In order to carry out evaluation when the timer PASS/FAIL and all tests have completed, the STOP hold setting is not valid.
- An **UPPER** / **LOWER** **FAIL** result will appear under the following forced terminations
  - (1) When the average measurement value, etc. is not completely processed immediately after the start of a test, etc.
  - (2) When test abnormalities occur due to voltage instabilities
  - (3) When the measurement current does not exceed the upper-limit during ramp-up and ramp-down in a withstanding test
  - (4) When the range cannot be determined by auto-range in the delay during the insulation-resistance measurement.
- Evaluation will not be carried out in forced terminations noted in "Chapter 5 Automatic Test".

## 6.4 Continue testing even after FAIL result is shown (Continuous Test Mode, Only Withstanding-Test)

See "Appendix2 List of Optional Functions" (p. A4)

Set the instrument to continue or discontinue the test when a NG test result is shown.

Under this function, the test will continue with **FAIL** lighting up next to UPPER or LOWER until the test time has run out, except for under the following conditions. When the test is continued under an NG result, the instrument will buzz and stop the test under the following conditions.

- (1) When a current higher than about 24 mA (20 mA-range) or about 12 mA (10 mA-range) is detected in a withstanding test (UPPER FAIL).
- (2) When broken wire or poor connection is detected in Contact Check function (**Err** message)

See "3.1.7" "4.1.5 Setting the Confirmation Voltage used for upper and lower-limits for Contact Check"

When FAIL hold is set, the test will hold when the test time has run out.

1. (READY is lit)

Make sure the **READY** lamp is lit on the screen.

\* **READY** will not be displayed during the Double Action setting.

2.

SHIFT

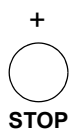

Press the **STOP** key while holding down the **SHIFT** key to display the optional screen (page 1).



3.



Press the **▶** key to move the flashing cursor to the position of page, and then press the **▲** / **▼** keys to display the optional screen (page 2).



4.



Press the **▶** key to move the flashing cursor to the position of Continuous Test Mode.

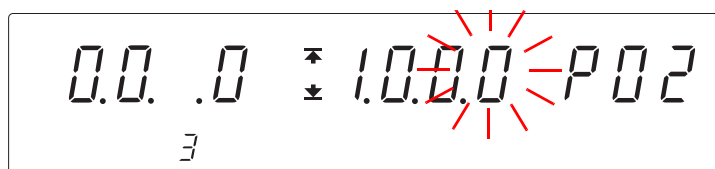

5.



or



Press the **▲** / **▼** keys to select the mode.

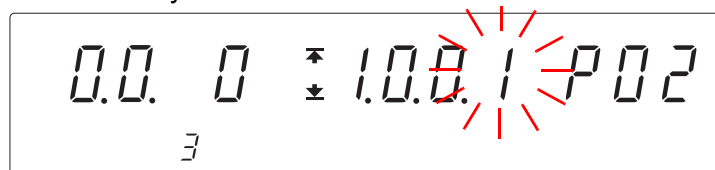

<Ex.> Select Continuous Test ON mode.

- 0: Continuous Test Mode OFF  
(Test completes when an NG result is shown) (Initial setting)
- 1: Continuous Test Mode ON  
(Continue testing even when NG result is shown)

6.5 Limiting the FAIL Hold Cancellation (FAIL mode)

6.

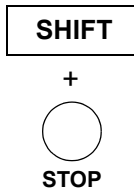

Press the **STOP** key while holding down the **SHIFT** key to complete the setting value.  
The instrument reverts to the READY state.

To continue to the setting for the next item, press the **▶** key.

**NOTE**

When carrying out continuous test mode setting, the maximum current detected and the timer will be displayed at the end of the test. Sometimes a current higher than the maximum current displayed during testing may be displayed because the display may not capture the fluctuations in current quick enough.

## 6.5 Limiting the FAIL Hold Cancellation (FAIL mode)

See "Appendix2 List of Optional Functions" (p. A4)

FAIL mode is a function enabling users to cancel the FAIL hold status only with the **STOP** key on the main instrument.

1.

(**READY** is lit)

Make sure the **READY** lamp is lit on the screen.

\* **READY** will not be displayed during the Double Action setting.

2.

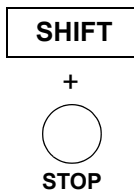

Press the **STOP** key while holding down the **SHIFT** key to display the optional screen (page 1).



3.



Press the **▶** key to move the flashing cursor to the position of FAIL mode.



4.

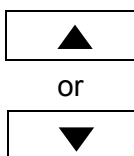

Press the **▲** / **▼** keys to select the mode.

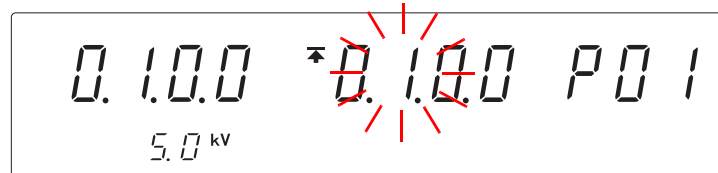

<Ex.> FAIL mode is set to ON.

**0**: FAIL mode is OFF  
(Cancellation of FAIL hold status is possible with all STOP functions) (Initial setting)

**1**: FAIL mode is ON (Cancellation of FAIL hold status is only possible with **STOP** key on the main instrument.)

5.

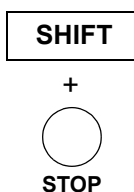

Press the **STOP** key while holding down the **SHIFT** key to complete the setting value.  
The instrument reverts to the READY state.

To continue to the setting for the next item, press the **▶** key.



## 6.6 Changing the Output Voltage during the withstanding test

The output voltage can be changed and the withstanding condition can be confirmed during the withstanding test.

### **! DANGER**

- To prevent electric shock, never touch the tested object or test lead.
- When changing the output voltage from RS-232C or GP-IB, it is difficult to grasp the timing of voltage changes as the voltage changes automatically. As electric shock accidents can happen easily, take measures to prevent people from coming near the instrument or the tested object when changing the output voltage automatically.

### **! CAUTION**

- When the tested object in use shows dependency on voltage (impedance of ceramic condenser, etc.), the waveforms of the output voltage may become distorted. The tested object may malfunction depending on the distortion of the waveforms.
- When the tested object in use possesses an inductivity like a coil, a voltage higher than the pre-set voltage may appear transitionally, causing damage in the tested object.

### **NOTE**

- The tested object may damage if a voltage higher than necessary is supplied. Be careful when setting the output voltage to ensure that the tested object does not receive a voltage higher than necessary.
- A contact error will occur when the output voltage is changed during the test and the contact check upper-limit voltage and lower-limit voltage are exceeded.

6

### When changing the voltage using the panel key

1. See "9.5 Interface Command "START"" (p. 188),  
Effecting the output voltage change
2. Start the test.
3. Move on to the next key, taking care not to touch the tested object and test lead during the test.  
To increase the test voltage:  
 ON/OFF + ▲ ..... Increasing the voltage by 10 V each  
 SHIFT + ▲ ..... Increasing the voltage by 100 V each  
 To decrease the test voltage:  
 ON/OFF + ▼ ..... Decreasing the voltage by 10 V each  
 SHIFT + ▼ ..... Decreasing the voltage by 100 V each

Note: Test voltage changed during output will not be saved

### To change the voltage in RS-232C and GP-IB

1. See "9.5 Interface Command "START"" (p. 188),  
Effecting the output voltage change
2. Start the test.
3. Send voltage setting command from RS-232C and GP-IB during testing  
":CONFigure:WITHstand:VOLTage voltage value (0.20kV to 5.00 kV)"

Note: Test voltage changed during output will not be saved

## 6.7 Insulation-Resistance Test Termination Mode

See "Appendix2 List of Optional Functions" (p. A4)

When performing an insulation-resistance test, set whether you want to conduct the test for the set test time regardless of the decision, terminate the test when PASS screening is performed, or terminate the test when FAIL screening is performed. (Insulation-resistance mode only.)

**0: Test for set time (Timer Ended status mode) (Initial setting)**

The test is only conducted for the set time, and the value is decided when the test is terminated. When the test time timer is OFF, the tests will continue with no evaluation.

**1: Terminate test at PASS screening (PASS Ended status mode)**

The test is terminated when PASS screening is conducted within the set time. If PASS screening is not conducted within the set time, the test is terminated when FAIL screening is conducted after the set time. When the test time timer is OFF, the tests will continue with no evaluation.

**2: Terminate test at FAIL screening (FAIL Ended status mode)**

The test is terminated when FAIL screening is conducted within the set time (excluding delay time). If FAIL screening is not conducted within the set time, the test is terminated when PASS screening is conducted after the set time. When the test time timer is OFF, the tests will continue with no evaluation. "6.4 Continuous Test Mode" setting will be ignored.

**1.** (READY is lit)

Make sure the **READY** lamp is lit on the screen.

\* **READY** will not be displayed during the Double Action setting.

**2.**

SHIFT

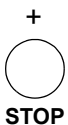

Press the **STOP** key while holding down the **SHIFT** key to display the optional screen (page 1).



**3.**



Press the **▶** key to move the flashing cursor to the position of page, and then press the **▲ / ▼** keys to display the optional screen (page 2).



or



4.



Press the ► key to move the flashing cursor to the position of insulation-resistance test termination mode.



5.

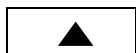

or



Press the ▲ / ▼ keys to select the mode.



<Ex.> Select "Terminate test at FAIL screening".

- 0: Test for set time (Initial setting)
- 1: Terminate test at PASS screening
- 2: Terminate test at FAIL screening

6.



+



STOP

Press the **STOP** key while holding down the **SHIFT** key to complete the setting value.

The instrument reverts to the READY state.

To continue to the setting for the next item, press the ► key.

### NOTE

- Any of the following settings is useful during a test on a tested object with capacity properties.
  - (1) "0: Test for set time"
  - (2) "1: Terminate test at PASS screening", and set the delay time necessary for charging.
  - (3) "2: Terminate test at FAIL screening", and set the delay time necessary for charging.
- When the test time is set to OFF, the setting of this mode is invalid. Press the **STOP** key to terminate the test.

### "0: Test for set time"

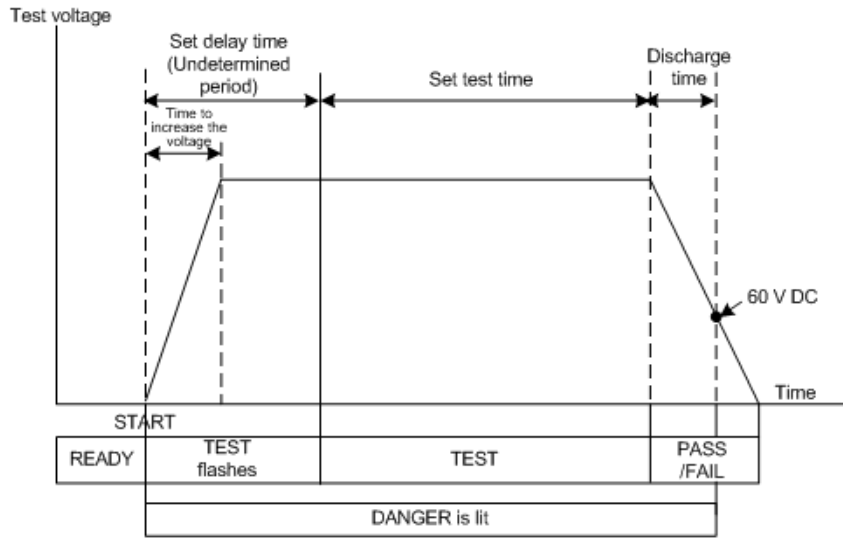

### "1: Terminate test at PASS screening"

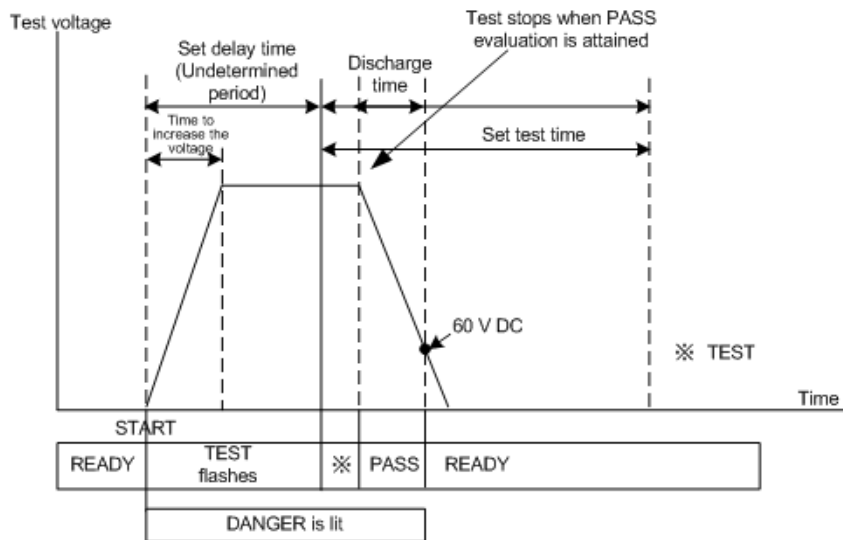

### "2: Terminate test at FAIL screening"

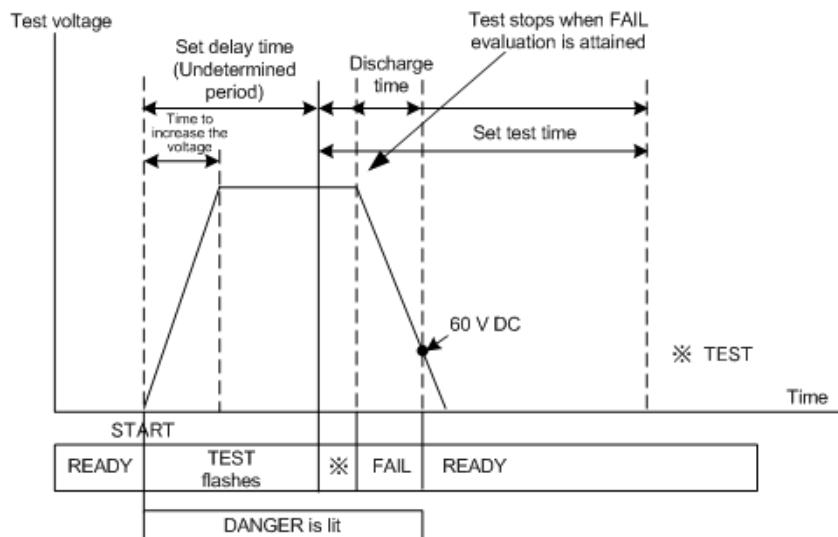

## 6.8 Auto-range for insulation-resistance test

See "Appendix2 List of Optional Functions" (p. A4)

Set fixed or automatic setting for range for insulation-resistance test.

When the fixed range (initial setting) is set, the range is fixed by the test voltage value and lower-limit value. When the automatic range is set, the range changes automatically according to the measurement value.

1. (READY is lit)

Make sure the **READY** lamp is lit on the screen.

\* **READY** will not be displayed during the Double Action setting.

2.

SHIFT

+



STOP

Press the **STOP** key while holding down the **SHIFT** key to display the optional screen (page 1).



3.



Press the **▶** key to move the flashing cursor to the position of page, and then press the **▲** / **▼** keys to display the optional screen (page 2).



or



4.



Press the **▶** key to move the flashing cursor to the position of insulation-resistance measurement range.



5.



or



Press the **▲** / **▼** keys to select the mode.



<Ex.> Select the "Auto range"

0: Fixed range (Initial setting)

1: Auto range

6.

SHIFT

+



STOP

Press the **STOP** key while holding down the **SHIFT** key to complete the setting value.

The instrument reverts to the READY state.

To continue to the setting for the next item, press the **▶** key.

**NOTE**

- For details on the relationships among the test-voltage values, lower-limit test values, and resistance measurement range, see "4.1.2 Setting the Upper (Lower) Limit Value" (p. 51).
- When the auto range is used, it is switched according to measured values. Due to the range-switching time, a certain amount of time is required for a measured value to be displayed (approximately 1.5 seconds).

## 6.9 Status Out



See "Appendix2 List of Optional Functions" (p. A4)



Do not connect any device which requires a current of more than 0.5 A to the relay terminal for status out. It may cause the device to malfunction.

The status out relay can be switched ON or OFF by setting a few conditions. The following are the conditions that can be set.

The status out relay connection will turn ON as long as any one of the conditions is met.

H.V.ON	High voltage output. Shown together with <b>DANGER</b> lamp.
TEST	Testing. When <b>TEST</b> lights up or flashes.
PASS	PASS status. When <b>PASS</b> lights up.
FAIL	FAIL status. When <b>FAIL</b> lights up.
INT.LOCK	Interlock status.
READY	READY status. When <b>READY</b> lights up.
EXT.CONT.	When controlled externally. Controlled by external I/O and remote control box (" <b>EXT</b> " lights up on the screen).
POWER.ON	When the power is switched on.

### Specifications for Relay Terminal

Maximum input voltage	150 V AC, 30 V DC
Maximum contact current	0.5 A
Rated wire	Single wire : $\phi 1.2$ mm (AWG16) Stranded wire: $1.25$ mm <sup>2</sup> (AWG16), wire diameter 0.18 mm or more
Usable wire	Single wire : $\phi 0.4$ to $\phi 1.2$ mm (AWG26 to 16) Stranded wire: 0.25 to $1.25$ mm <sup>2</sup> (AWG22 to 16)
Wire diameter	0.18 mm or more
Standard length of removed wire section	11 mm

All conditions are invalid in the initial setting.

## Procedure for Connecting (To rotate a commercially available warning lamp)

\*The commercially available warning lamp must satisfy the specifications of the relay terminal.



To prevent electric shock, never plug the power cord into the power outlet during the whole connection process, including the cord processing part.

Rear panel

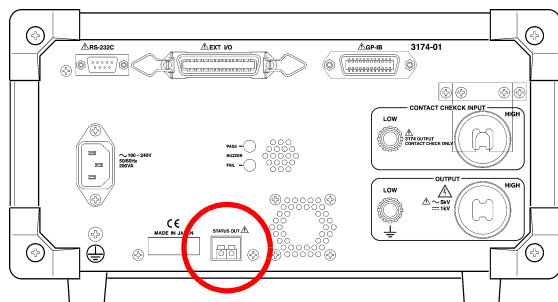

Modified 100 V AC power cord

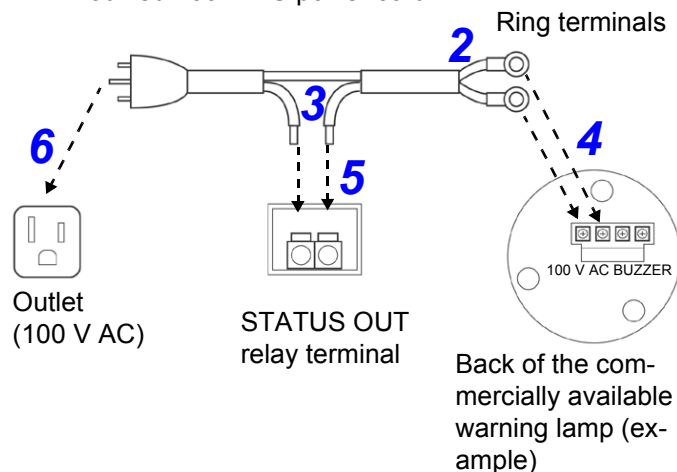

5

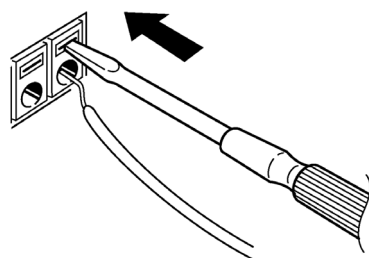

1. Make sure that the power switch is turned off.

2. Prepare a 100 V AC power cord, remove the socket end as illustrated, and modify the inner lines into ring terminals. When you are using a grounded three-core power cord, wrap the ground line with insulated tape, as it is not used.

3. Expose the inner lines of the power cord at the center of the cord, and cut one of them. Expose the inner wire of the cut line by stripping the outer covering.

4. Connect the ring terminals to the 100 V AC terminals on the back of the commercially available warning lamp. For details, refer to the instruction manual supplied with the commercially available warning lamp.

5. Connect the stripped wire to the STATUS OUT relay terminal on the rear panel of the instrument.

(1) Press the button on the terminal board with a flathead screw driver.

(2) Insert the lead wire while pressing the button.

(3) When the flathead screw driver is removed, the lead wire is secured.

6. Plug the modified power cord into the power outlet.

### NOTE

Only 100 V AC electrical outlets can be used.

### Setting output conditions

**1.** (READY is lit) Make sure the **READY** lamp is lit on the screen.

\* **READY** will not be displayed during the Double Action setting.

**2.** Press the **STOP** key while holding down the **SHIFT** key to display the optional screen (page 1).

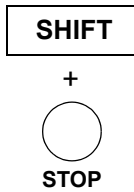

**3.** Press the **▶** key to move the flashing cursor to the position of page, and then press the **▲ / ▼** keys to display the optional screen (page 3).

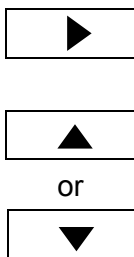

**4.** Press the **▶** key to move the flashing cursor to the Grid showing the conditions to be set.

The diagram shows an example of setting the interlock mode.  
For details, see "Appendix2 List of Optional Functions" (p. A4)



**5.** Press the **▲ / ▼** keys to select the mode.

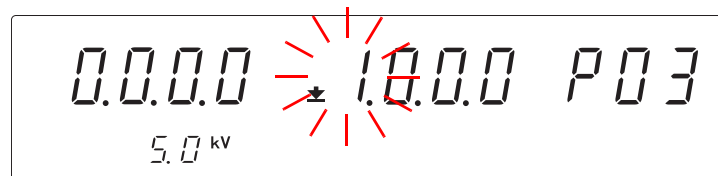
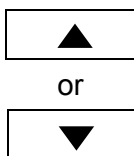

**0:** Remove condition from status out condition  
**1:** Set the condition

**6.** Press the **STOP** key while holding down the **SHIFT** key to complete the setting value.

The instrument reverts to the **READY** state.

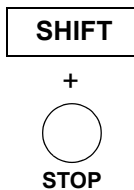

To continue to the setting for the next item, press the **▶** key.

**NOTE**

The status out relay connection will turn ON as long as any one of the conditions is met.



# Saving / Loading test conditions

## Chapter 7

### 7.1 Saving the Test Conditions

Up to 8 conditions can be saved for the withstanding and insulation-resistance tests respectively. Refer to "7.2 Loading the Test Conditions" (p. 102) on how to load these data.

The settings for optional functions and status out will still be saved even when the power is switched off, but they will not be saved as individual test information.

#### Saved items in the withstand-voltage test

test-voltage frequency (50 Hz AC/60 Hz AC), test-voltage value, upper-limit test value, lower-limit test value, test-time, ramp-up time, ramp-down time, initial voltage for ramp-up, contact check upper-limit voltage, contact check lower-limit voltage



#### Saved items in the insulation-resistance test

test-voltage value, lower-limit test value, upper-limit test value, test-time, delay time, contact check upper-limit voltage, contact check lower-limit voltage

#### **NOTE**

When the Save setting is set to OFF, OFF will be saved. Changing the setting to ON using the **ON/OFF** key under the READY mode will also save the setting at the same time.

## Procedure for Saving



1.  /  Setting test conditions to be saved for the withstand-voltage test or insulation-resistance test.

Withstand-voltage test : "3.1 Setting the Test-Conditions" (p. 31)

Insulation-resistance test : "4.1 Setting the Test Conditions" (p. 49)

2.  (READY is lit) Make sure the **READY** lamp is lit on the screen.

\* **READY** will not be displayed during the Double Action setting.

3.  +  Press the  key while holding down the **SHIFT** key to display the save screen.

File No. of test conditions selected previously will be displayed.

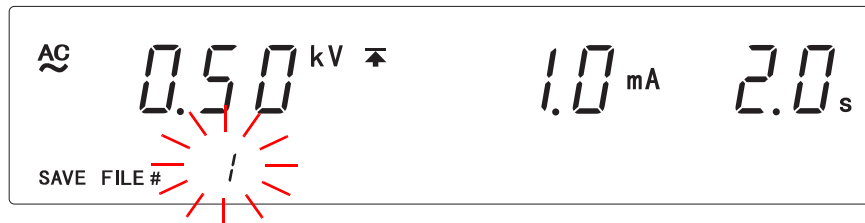



<Ex.>

File No. of previously selected file: 1



test type: AC withstand-voltage test, test-voltage: 0.5 kV

upper-limit test value: 1.0 mA, test-time: 2.0 s

- To confirm the test-frequency and initial ramp-up value →  key
- To confirm the lower-limit test value →  key
- To confirm the ramp-up time and ramp-down time → **ON/OFF** key
- To confirm the contact check upper (lower)-limit voltage → **LOCK** key  
(**LOCAL** key)

4.  or  Press the  /  keys to select the File No. to be saved.

All saved data will overwrite the old data. Confirm whether it is all right to delete previously saved test conditions.

5.  +  Press the  key while holding down the **SHIFT** key to save the test conditions.

The instrument reverts to the READY state.

Press the **STOP** key to cancel saving.

**Screen for With-stand-voltage test**

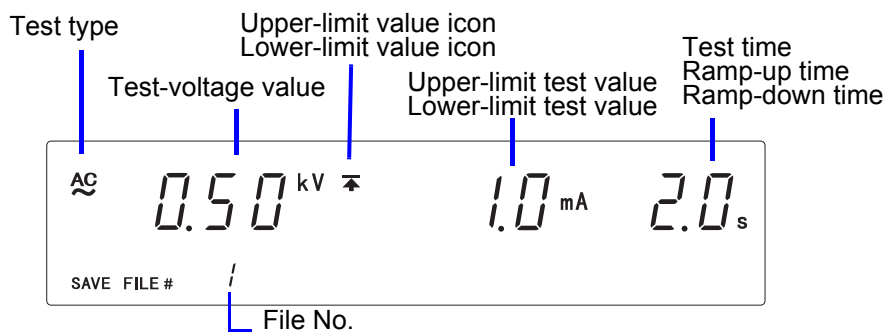

Test type	“AC” lights up during withstanding testing.
Test-voltage value	Saved test voltage.
Upper-limit value icon	Lights up when indicating the upper-limit test value.
Lower-limit value icon	Lights up when indicating the lower-limit test value.
Upper-limit test value Lower-limit test value	Lit up upper-limit icon indicates saved upper-limit test value, lit up lower-limit icon indicates saved lower-limit test value.
Test time Ramp-up time Ramp-down time	Indicates saved test time, ramp-up time and ramp-down time.
File No.	Indicates the File No. of saved test conditions.

Switch for test-voltage value, test frequency and initial ramp-up value

→ ◀ key

Switch for upper-limit test value and lower-limit test value

→ ▶ key

Switch for test time, ramp-up time and ramp-down time

→ ON/OFF key

Switch for test-voltage value and contact check upper (lower)-limit value

→ LOCK key (LOCAL key)

7

**Screen for Insulation-resistance test**

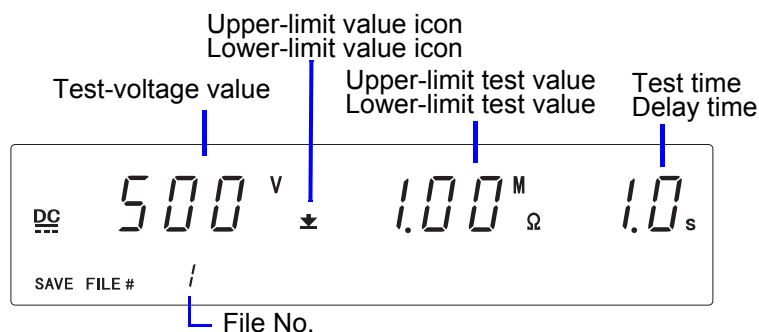

Test-voltage value	Saved test voltage.
Upper-limit value icon	Lights up when indicating the upper-limit test value.
Lower-limit value icon	Lights up when indicating the lower-limit test value.
Upper-limit test value Lower-limit test value	Lit up upper-limit icon indicates saved upper-limit test value, lit up lower-limit icon indicates saved lower-limit test value.
Test time Delay time	Indicates saved test time and delay time.
File No.	Indicates the File No. of saved test conditions.

Switch for upper-limit test value and Lower-limit test value

→ ▶ key

Switch for test time and delay time

→ ON/OFF key

Switch for test-voltage value and contact check upper (lower)-limit value

→ LOCK key (LOCAL key)

### 7.2 Loading the Test Conditions

Convenient function enabling test to start immediately by loading pre-set test conditions for withstanding and insulation-resistance tests. Refer to "7.1 Saving the Test Conditions" (p. 99) on how to save test conditions.

The settings for optional functions and status out will still be saved even when the power is switched off, but they will not be saved as individual test information.

#### Saved items in the withstand-voltage test

test-voltage frequency (50 Hz AC/60 Hz AC), test-voltage value, upper-limit test value, lower-limit test value, test-time, ramp-up time, ramp-down time, initial voltage for ramp-up, contact check upper-limit voltage, contact check lower-limit voltage

#### Saved items in the insulation-resistance test

test-voltage value, lower-limit test value, upper-limit test value, test-time, delay time, contact check upper-limit voltage, contact check lower-limit voltage

#### Procedure for Loading

1. 

Set to the test mode for test conditions to be load.

2.  (READY is lit)

Make sure the **READY** lamp is lit on the screen.

\* **READY** will not be displayed during the Double Action setting.

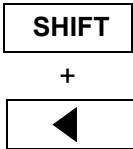
3. 

Press the **◀** key while holding down the **SHIFT** key to display the load screen.

File No. of test conditions loaded previously will be displayed.

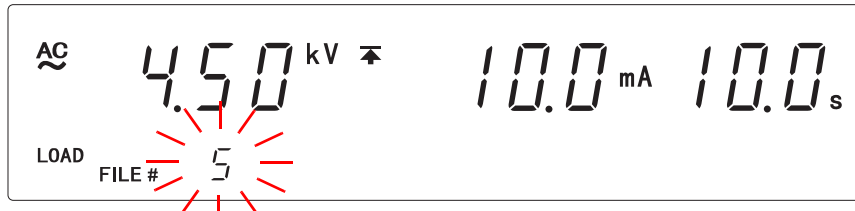

<Ex.>

File No. of previously loaded file: 5

test type: AC withstand-voltage test, test-voltage: 4.5 kV

upper-limit test value: 10 mA, test-time: 10.0 s

- To confirm the test-frequency and initial ramp-up value → **◀** key
- To confirm the lower-limit test value → **▶** key
- To confirm the ramp-up time and ramp-down time → **ON/OFF** key
- To confirm the contact check upper (lower)-limit voltage → **LOCK** key (**LOCAL** key)

4.  or 

Press the **▲** / **▼** keys to select the File No. to be load.

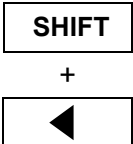
5. 

Press the **◀** key while holding down the **SHIFT** key to load the test conditions.

The instrument reverts to the READY state.

Press the **STOP** key to cancel loading.

# External Interface Chapter 8

## 8.1 Outline of External I/O

External I/O is found on the back of the instrument and indicates the different modes of the instrument, such as READY, TEST, etc. and PASS, FAIL results of tests with signals. It can also control the instrument when signals for starting the test, START, stopping the test, STOP or selecting a file, File Selection are inputted. It enables safe measurement by using interlock terminals.

See "8.3 Inter-lock Function" (p. 111)

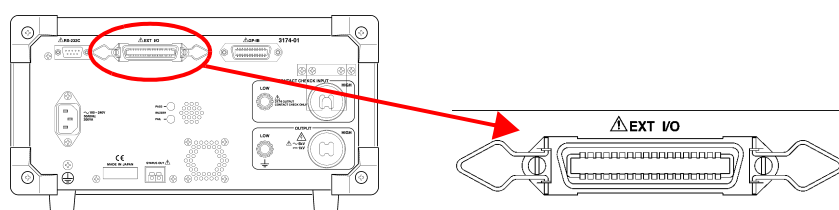

All signal lines are insulated internally with a photocoupler. A power voltage of 15 V (0.1 A), insulated from the internal supply, is output from the external I/O terminal. This voltage can be used as external power. If the unit power capacity is insufficient, add an external power supply.

### NOTE

There is a priority hierarchy for the **START** keys.

Priority hierarchy: Remote Control Box > EXT I/O > Front panel of the 3174 (3174-01)

Note that when a **START** key with a higher priority is in use, lower-priority keys are disabled.

<Ex.>

- When  $\overline{\text{EXT-E}}$  of the external I/O terminal is at LOW level (**EXT** lights up), the unit **START** key is disabled.
- If you use the Remote Control Box, the START signal for the external I/O terminal is disabled.
- The  $\overline{\text{TEST}}$  signal is turned ON when TEST on the fluorescent indicator lights up. The H.V.ON signal is turned on when the **DANGER** lamp lights up. The two signals are turned OFF at the same time.
- Upon startup of the test, although **TEST** flashes until the output voltage reaches the set test voltage or during the ramp-up time, the  $\overline{\text{TEST}}$  signal is ON.

## 8.1.1 Explanations of signal line

Use the following external I/O connectors or their equivalents:

### Compatible connector

57-30360 (DDK Ltd.)  
 57E-30360 (DDK Ltd.)  
 57F-30360 (DDK Ltd.)  
 57FE-30360 (DDK Ltd.)  
 RC30-36P (Hirose Electric)

### Connector pin numbering

Connector of the 3174, 3174-01 main unit: 57RE-40360-730B (D29) (DDK Ltd.)

Pin number	I/O	Signal line name	Pin number	I/O	Signal line name
1	OUT	$\overline{\text{READY}}$	19	OUT	Not used
2	OUT	$\overline{\text{L-FAIL}}$	20	OUT	Not used
3	OUT	$\overline{\text{U-FAIL}}$	21	OUT	Not used
4	OUT	$\overline{\text{PASS}}$	22	IN	$\overline{\text{MEM-0}}$
5	OUT	$\overline{\text{TEST}}$	23	IN	$\overline{\text{MEM-1}}$
6	OUT	$\overline{\text{H.V.ON}}$	24	IN	$\overline{\text{MEM-2}}$
7	IN	$\overline{\text{EXT-E}}$	25	IN	$\overline{\text{MEM-3}}$
8	IN	$\overline{\text{START}}$	26	OUT	Not used
9	IN	$\overline{\text{STOP}}$	27	IN	$\overline{\text{MEM-E}}$
10	IN	$\overline{\text{INT.LOCK}}$	28	OUT	$\overline{\text{MODE0}}$
11	OUT	$\overline{\text{W-MODE}}$	29	OUT	$\overline{\text{MODE1}}$
12	OUT	$\overline{\text{I-MODE}}$	30	OUT	Not used
13	OUT	$\overline{\text{W-FAIL}}$	31	OUT	Not used
14	OUT	$\overline{\text{I-FAIL}}$	32	OUT	Not used
15	IN	ISO.COM	33	OUT	ISO.DCV
16	IN	ISO.COM	34	OUT	ISO.DCV
17	IN	ISO.COM	35	OUT	ISO.DCV
18	IN	ISO.COM	36	OUT	ISO.DCV

18 ... .. 1

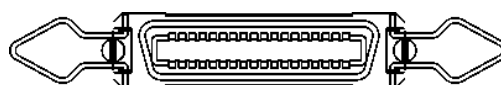

36 ... .. 19

### Function of the signal line

Signal line name	I/O	Function
$\overline{\text{READY}}$	OUT	LOW level in the READY state
$\overline{\text{L-FAIL}}$	OUT	LOW level in the FAIL state at LOWER (minimum value)
$\overline{\text{U-FAIL}}$	OUT	LOW level in the FAIL state at UPPER (maximum value)
$\overline{\text{PASS}}$	OUT	LOW level in the PASS state
$\overline{\text{TEST}}$	OUT	LOW level in the TEST state
$\overline{\text{H.V.ON}}$	OUT	LOW level when a voltage is generated in the output terminal
$\overline{\text{EXT-E}}$	IN	At LOW level, the external I/O input signal is active. $\overline{\text{INT.LOCK}}$ or $\overline{\text{STOP}}$ remains active regardless of this signal. Changing this signal during testing will forcibly terminate the test.
$\overline{\text{START}}$	IN	LOW level is equivalent to pressing the instrument <b>START</b> key and provides the same functions.
$\overline{\text{STOP}}$	IN	LOW level is equivalent to pressing the unit <b>STOP</b> key and provides the same functions. This signal is valid regardless of $\overline{\text{EXT-E}}$ status.
$\overline{\text{INT.LOCK}}$	IN	Inter-lock function terminal. This signal is always active regardless of the status of the $\overline{\text{EXT-E}}$ terminal. When connected to ISO.GND, this terminal cancels the Interlock function, enabling the unit to function properly. When there is no connection, "Err0" is displayed and all keys are invalid. To activate the Inter-lock function, set the optional Inter-lock function to "1: ON". Use this terminal for a protective device against electric shock that uses an area sensor or the like. See "8.3 Inter-lock Function" (p. 111)
$\overline{\text{W-MODE}}$	OUT	LOW level when performing a withstand-voltage test in the withstand-voltage test screen.
$\overline{\text{I-MODE}}$	OUT	LOW level when performing an insulation-resistance test in the insulation-resistance test screen.
$\overline{\text{W-FAIL}}$	OUT	LOW level in FAIL state during a withstand-voltage test.
$\overline{\text{I-FAIL}}$	OUT	LOW level in FAIL state during an insulation-resistance test.
$\overline{\text{MEM-E}}$	IN	At LOW level, the memory selection terminal (MEM-0 to 4) is active.
MEM-0 to MEM-3	IN	Selection terminal for saved test conditions.
MODE0, MODE1	OUT	Indicates the current test mode.
ISO.COM	IN	Common terminal insulated from GND found inside the instrument. Used to temporarily activate the external I/O function.
ISO.DCV	OUT	Outputs a power voltage of 15 V (100 mA), isolated from the internal power supply. Used to temporarily activate the external I/O function.

## 8.1.2 Connecting the External I/O connector



- Always turn both devices OFF when connecting and disconnecting an interface connector. Otherwise, an electric shock accident may occur.
- To avoid electric shock or damage to the equipment, always observe the following precautions when connecting to external I/O.
  - (1) Always turn off the power to the instrument and to any devices to be connected before making connections.
  - (2) Be careful to avoid exceeding the ratings of external I/O signal.

For safety reasons, confirm before connecting.

Front panel

The **DANGER** lamp is OFF.

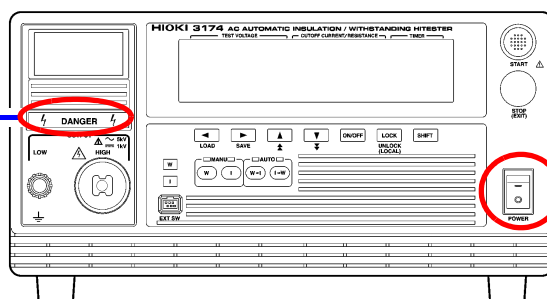

The power switch is OFF.

Rear panel

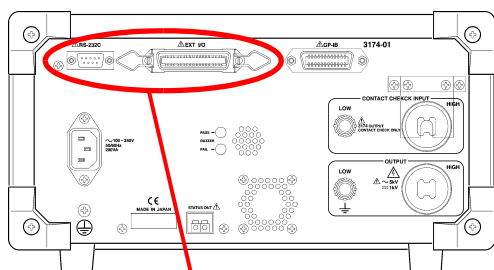

1. Make sure that the power switch is turned off.
2. Connect EXT I/O to the EXT I/O connector on the back of the instrument.
3. Fasten the EXT I/O with the EXT I/O connector clips.

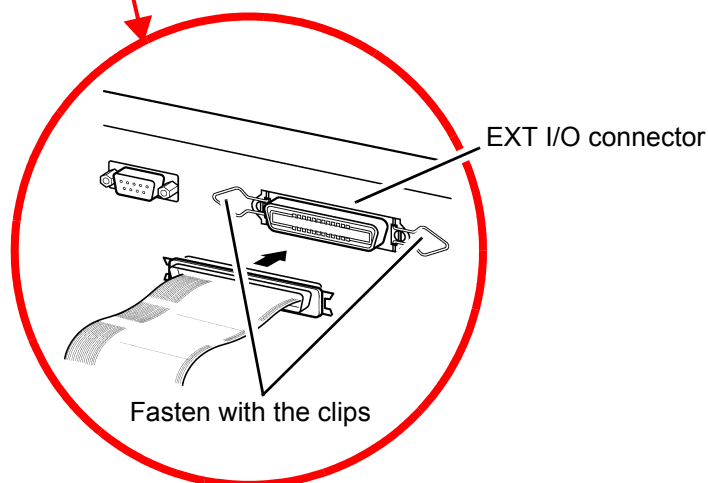



## 8.2 Example of Signal Connection

- The instrument can be controlled externally using the external I/O input signal. Saved test condition can also be selected. Provide a connector that conforms to the external I/O specifications.
- To enable the external I/O signal, set the  $\overline{\text{EXT-E}}$  signal (Pin 7) to LOW level. Connect the  $\overline{\text{EXT-E}}$  signal to ISO.COM for the GND signal (Pins 15 to 18), which is insulated from the instrument's internal power supply.
- To enable the memory selection terminal, set the  $\overline{\text{MEM-E}}$  signal (pin 27) to LOW level (low-level period: 100 ms or more). When downloading the saved test data, connect the  $\overline{\text{MEM-E}}$  signal to ISO.COM for the GND signal (Pins 15 to 18), which is insulated from the instrument's internal power supply.

See "Connector pin numbering" (p. 104)

### Example of Input Signal Connection

#### EXT I/O Input signals Specifications

Input signal	Active low input (photocoupler isolated)	
Maximum input voltage	30 V DC	
HIGH level voltage (HI)	More than 15 V DC or open	
LOW level voltage (LO)	5 V DC or less	
Signal name	$\overline{\text{EXT-E}}$	: External I/O valid
	$\overline{\text{START}}$	: Test starts
	$\overline{\text{STOP}}$	: Test stops
	$\overline{\text{INT.LOCK}}$	: Inter-lock
	$\overline{\text{MEM-E}}$	: Memory selection terminal valid
	MEM-0 to MEM-3	: Memory selection terminal

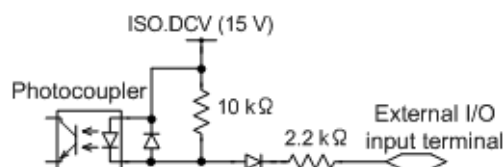

### <Ex. 1> Control using the external switch

To control the START and STOP signals using a relay or switch, make connections as shown below:

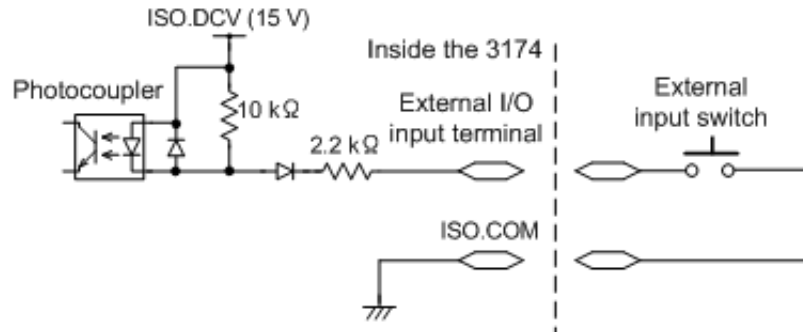

### **NOTE**

For connection to the input signal, provide a circuit that protects the relay and switch from chattering to prevent malfunctioning.

### <Ex. 2> Control using the transistor

For control using a transistor or FET, make connections as shown below. Design the respective signals at the minimum 6 mA.

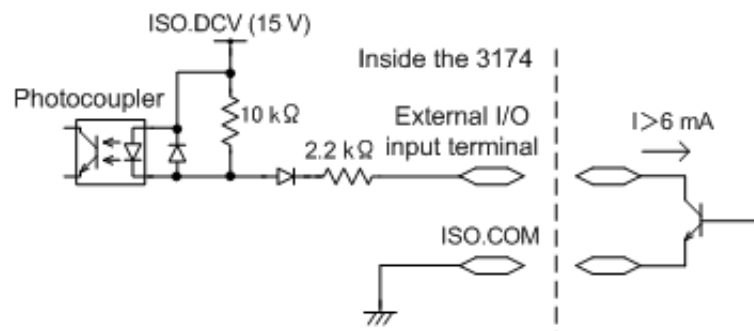

## Example of Output Signal Connection

The output signal becomes LOW level depending on the condition of the instrument. Prepare a connector that conforms to the External I/O Specifications. For details, refer to output examples in "8.6 Timing Chart" (p. 115)

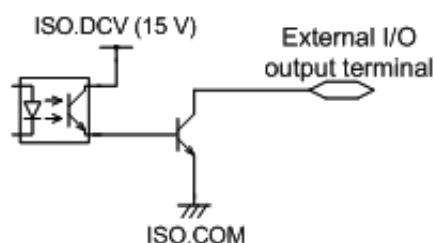

### EXT I/O Output signals Specifications

Output signal	Open collector output	
Maximum load voltage	DC30 V	
Maximum output current	DC100 mA/1	
Output Saturation Voltage	1.5 V DC or less	
Signal name	$\overline{\text{READY}}$ : READY mode $\overline{\text{U-FAIL}}$ : UPPER FAIL status $\overline{\text{L-FAIL}}$ : LOWER FAIL status $\overline{\text{PASS}}$ : PASS status $\overline{\text{TEST}}$ : Testing $\overline{\text{H.V.ON}}$ : Supplying voltage $\overline{\text{W-MODE}}$ : Screen of withstand-voltage test $\overline{\text{I-MODE}}$ : Screen of insulation-resistance test $\overline{\text{W-FAIL}}$ : FAIL result for withstand test $\overline{\text{I-FAIL}}$ : FAIL result for insulation-resistance test $\overline{\text{MODE0 to 1}}$ : Status indicating signals	
	$\overline{\text{MODE1}}$ 1 (H) 1 (H) 0 (L) 0 (L)	$\overline{\text{MODE0}}$ 1 (H) W mode 0 (L) I mode 1 (H) W-I mode 0 (L) I-W mode

\* 1 (H) : transistor OFF  
 0 (L) : transistor ON

### <Ex. 1> Controlling the relay

To link the relay to an external device, make connections as shown below.

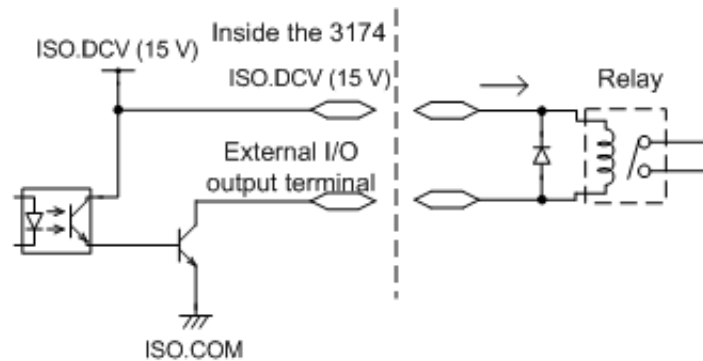

### **NOTE**

- A signal can absorb up to 100 mA.
- If the current capacity is not sufficient, connect a transistor or the like to the outside in order to amplify the current.
- When connecting an inductive load such as a relay, connect the diode in parallel with the coil.

### <Ex. 2> Obtaining a signal limit

To obtain a signal limit, make connections as shown below. In addition, check the output current.

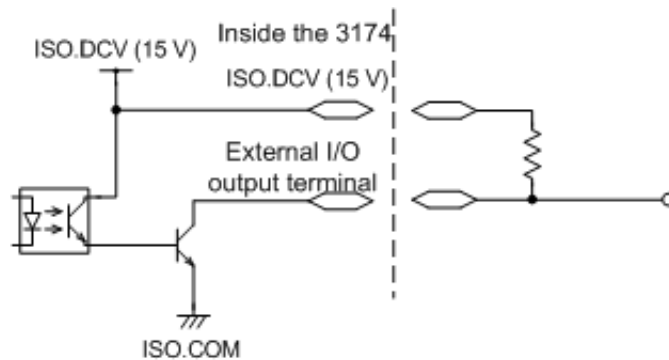

## 8.3 Inter-lock Function

See "Appendix2 List of Optional Functions" (p. A4)

The interlock function is a function to shut off power supply to the instrument by connecting with external devices. When the interlock function is in operation, all keys are invalid. Moreover, the interfaces, such as RS-232C interface, are disabled.

When the interlock function is set on the optional functions screen, the Pin 10 INT.LOCK of the external I/O will set the interlock in operation.

1. Connect Pin 10 INT.LOCK on the external I/O to ISO.GND (Pins 15 to 18).

See "Connector pin numbering" (p. 104)

2. (**READY** is lit) Make sure the **READY** lamp is lit on the screen.

\* **READY** will not be displayed during the Double Action setting.

3. Press the **STOP** key while holding down the **SHIFT** key to display the optional screen (page 1).

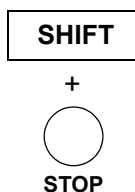

4. Press the **▶** key to move the flashing cursor to the position of inter-lock.



5. Press the **▲** / **▼** keys to select the mode.

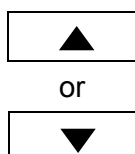

<Ex.> Inter-lock is set to ON.

**0**: Inter-lock is OFF (Initial setting)

**1**: Inter-lock is ON

6. Press the **STOP** key while holding down the **SHIFT** key to complete the setting value.

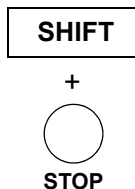

The instrument reverts to the READY state.

To continue to the setting for the next item, press the **▶** key.

**NOTE**

- The  $\overline{\text{INT.LOCK}}$  terminal is always active, regardless of the status of the  $\overline{\text{EXT-E}}$  terminal.
- If "0: OFF" is selected for "Inter-lock" in Optional Functions, the inter-lock function is inactive, regardless of the status of the  $\overline{\text{INT.LOCK}}$  terminal. The function is set at "0: OFF" by default. If the inter-lock function is to be used, be sure to select "1: ON"
- Interlock function can only be set when the  $\overline{\text{INT.LOCK}}$  (Pin 10) at the external I/O terminal is set to LOW. When the Pin is at HIGH, pressing the ▲ / ▼ keys will not change the "0: OFF" setting.
- When the interlock function is in operation, the instrument cannot communicate.

**Procedure for Using**

- The inter-lock function is active when the  $\overline{\text{INT.LOCK}}$  terminal is open, with the following displayed: To disable the function, connect the  $\overline{\text{INT.LOCK}}$  terminal to ISO.COM and set it to LOW level. The instrument changes to READY status once the inter-lock function is disabled.
- When selecting the "1:ON" at the "Inter-lock" for the optional function, the test will not be carried out unless the Pin 10 of the external I/O terminal is set to Low. In this case, "Err0" will be shown.

**Example of Connections**

For example, to ensure the safety of workers, the instrument and the tested object are placed in a box so that they are not in contact with each other. The door of the box cover is also equipped with a switch that works in combination with the inter-lock function. If a connection is made to the switch, the inter-lock function is enabled when the box cover is opened. When the cover is closed, the function is disabled, making the instrument ready for testing.

All keys are inactive provided that the inter-lock function is active. As a result, once the instrument is mounted in the box, the settings cannot be changed. In such a case, connect the setting adjustment switch the door switch such that these switches are arranged in parallel, as shown below:

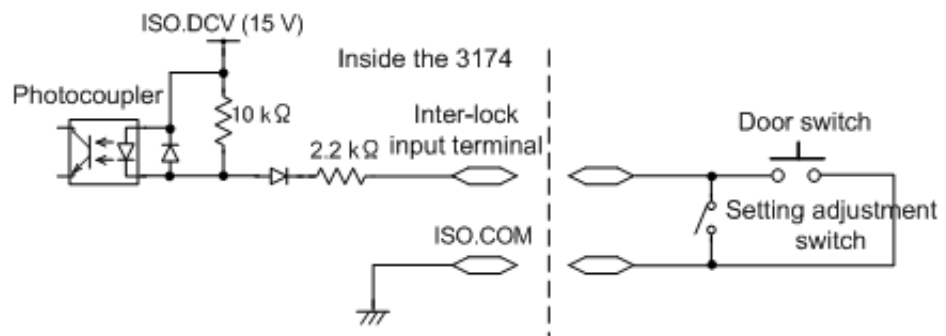

## 8.4 TEST-Signal Output

See "Appendix2 List of Optional Functions" (p. A4)

This function enables selection of whether the external I/O  $\overline{\text{TEST}}$  signal output is to include the **TEST** flashing time (ramp-up/down time).

1. (**READY** is lit)

Make sure the **READY** lamp is lit on the screen.

\* **READY** will not be displayed during the Double Action setting.

2.

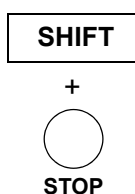

Press the **STOP** key while holding down the **SHIFT** key to display the optional screen (page 1).



3.



Press the **▶** key to move the flashing cursor to the position of page, and then press the **▲** / **▼** keys to display the optional screen (page 2).



4.



Press the **▶** key to move the flashing cursor to the position of TEST-signal output.

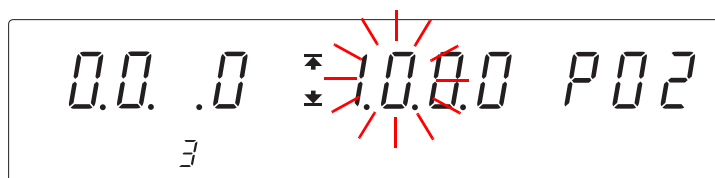

5.

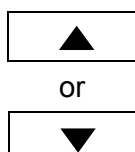

Press the **▲** / **▼** keys to select the mode.

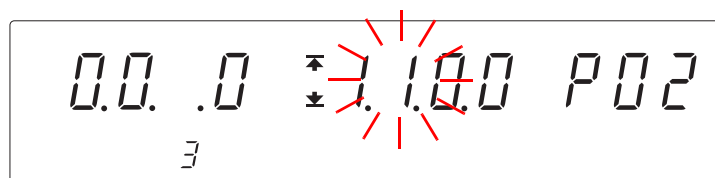

<Ex.> Select "Does not include **TEST** flashing time in TEST ON output signal."

**0**: TEST signal ON, while all test time including ramp-up and ramp-down time (Initial setting)

**1**: TEST signal ON, while set test time

**2**: TEST signal ON, only while ramp-up and ramp-down time

6.

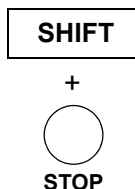

Press the **STOP** key while holding down the **SHIFT** key to complete the setting value.

The instrument reverts to the READY state.

To continue to the setting for the next item, press the **▶** key.

## 8.5 Selecting test mode and saved test condition

By saving setting values before hand, test conditions can be selected with the MEM-E and MEM-0 to 3 terminals on the external I/O terminals.

See "Chapter 7 Saving / Loading test conditions" (p. 99)

The follow explains how to load the saved settings from an external I/O.

1. Set the mode to load required saved test conditions.  
In READY mode, choose from the chart, "Memory Selection Terminals and Modes", the mode required by using MEM3 to MEM0 (22 pin to 25 pin) and set the MEM-E terminal (27 pin) to Lo. After completing the setting, set the MEM-E terminal to Hi.
2. In READY mode, choose from the chart, "Memory Selection Terminals and Memory Numbers", the required file number by using MEM3 to MEM0 and set the MEM-E terminal (27 pin) to Lo (low-level period: 100 ms or more). Setting conditions for the specified file will be loaded. After completing the setting, set the MEM-E terminal to Hi.
3. When carrying out tests in the W-I mode and I-W mode, set the mode for required tests following procedure 1.

### **NOTE**

In the Test Mode, test conditions cannot be loaded when W-I mode or I-W mode is selected. When carrying out tests in the W-I mode and I-W mode, load test conditions under W-mode and I-mode respectively before setting to W-I mode and I-W mode.

#### Memory selection terminal and memory numbers

Memory No.	Memory selection terminal			
	MEM-3	MEM-2	MEM-1	MEM-0
1	Hi	Hi	Hi	Hi
2			Lo	
3			Hi	
4			Lo	
5		Lo	Hi	Hi
6			Lo	
7			Hi	
8			Lo	
Not used	Lo	Hi	Hi	Hi
Not used			Lo	
Not used			Hi	
Not used			Lo	

#### Memory selection terminal and Mode

Mode	Memory selection terminal			
	MEM-3	MEM-2	MEM-1	MEM-0
W mode	Lo	Lo	Hi	Hi
I mode			Lo	
W → I mode			Hi	
I → W mode			Lo	



## 8.6 Timing Chart

### Starting the test

When a test begins, the  $\overline{\text{READY}}$  signal becomes HIGH level, and the  $\overline{\text{TEST}}$  signal and H.V.ON signal become LOW level.

The H.V.ON signal becomes LOW level with the voltage output.

The TEST signal changes at the same time **TEST** on the fluorescent indicator changes.

### During the withstand-voltage test

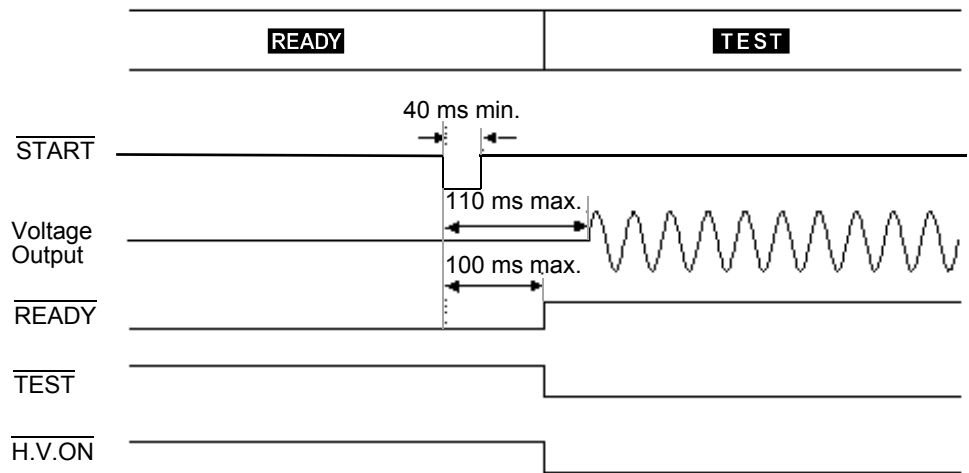

### During the insulation-resistance test

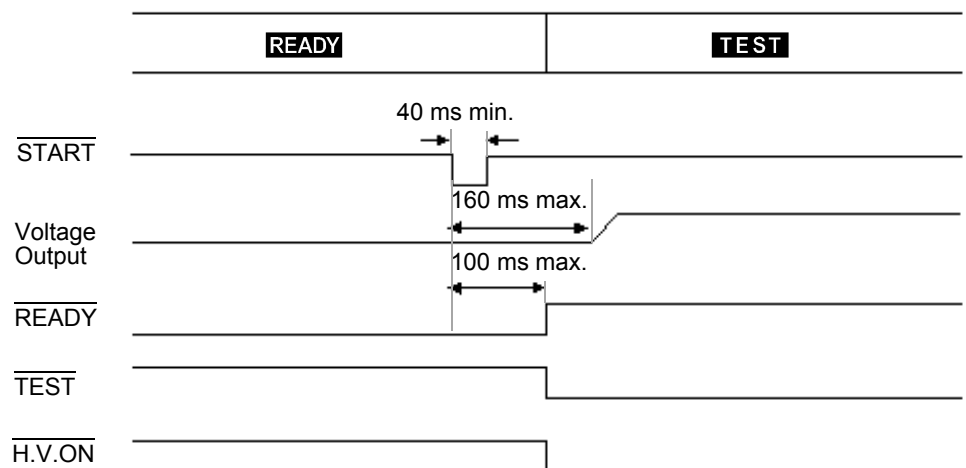

### During a test decision

The figure shows the timing chart of the instrument in PASS state after a test. In PASS state, the  $\overline{\text{TEST}}$  signal indicates HIGH level.

The H.V.ON signal remains at LOW level provided that the voltage between the output terminals remains unchanged, as the signal is synchronized with the **DANGER** lamp. (Below 30 V AC when performing an AC-withstand voltage test, or below 60 V DC when performing an insulation-resistance test.) Once the voltage reaches 0, the signal changes to HIGH level. The  $\overline{\text{PASS}}$  signal changes according to the **PASS** indicator on the fluorescent display. If the PASS hold function is enabled, the  $\overline{\text{PASS}}$  signal continues to indicate LOW level until the function is disabled.

When the Hold function is disabled or the instrument automatically returns to the READY state, the  $\overline{\text{PASS}}$  signal becomes HIGH level and the  $\overline{\text{READY}}$  signal becomes LOW level.

#### Withstand-voltage test (When the PASS hold function is not used)

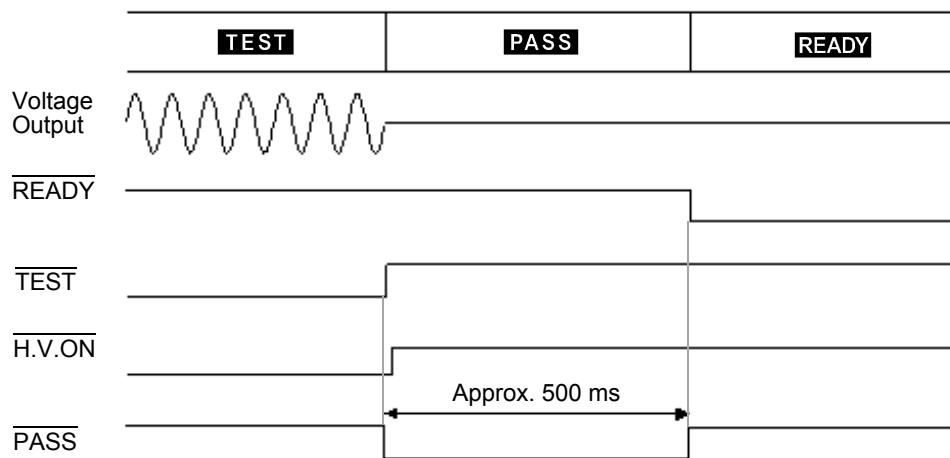

#### Insulation-resistance test (When the PASS hold function is not used)

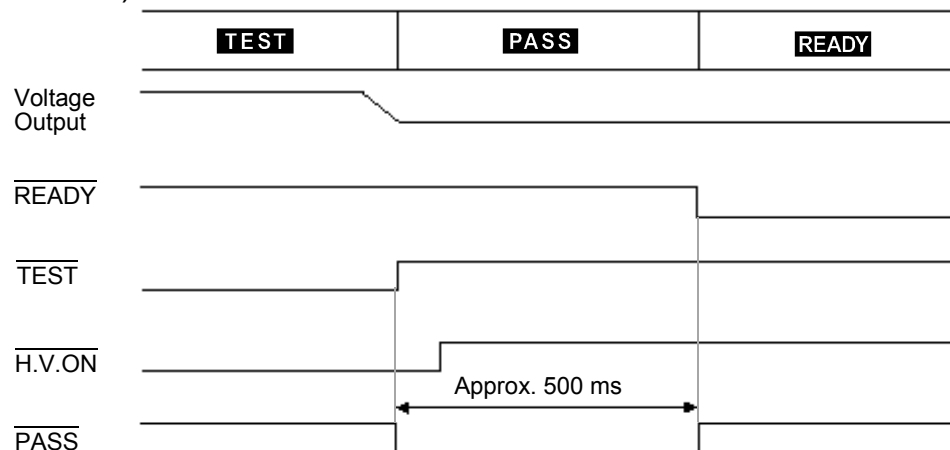

Even in the FAIL state, when UPPER FAIL is activated, the  $\overline{\text{U-FAIL}}$  signal becomes LOW level. Similarly, with LOWER-FAIL, the  $\overline{\text{L-FAIL}}$  signal becomes LOW level. If a withstand-voltage test fails, the  $\overline{\text{W-FAIL}}$  signal becomes LOW level. Similarly, if an insulation-resistance test fails, the  $\overline{\text{I-FAIL}}$  signal becomes LOW level.

When the FAIL Hold function is set, the signal remains at LOW level until the Hold function is disabled.

When the Hold function is disabled or the instrument automatically returns to the READY state, the  $\overline{\text{PASS}}$  signal becomes HIGH level and the  $\overline{\text{READY}}$  signal becomes LOW level.

## At forced termination

When the evaluation status during forced completion under the optional function mode is not ON, and when the **STOP** key is pressed to forcibly terminate testing, the instrument does not change to either PASS or FAIL status, as test screening is not performed. In this case, all evaluation signals will indicate Hi.

When this status is held even during HOLD function, it will remain Hi under the HOLD is cancelled. In the absence of status indicators (**READY/TEST/FAIL/PASS**) -- in the SETTING state, when set values are being saved or loaded, or when settings are being made for the optional functions -- all signals become HIGH level.

### Withstand-voltage test (When the hold function is not used)

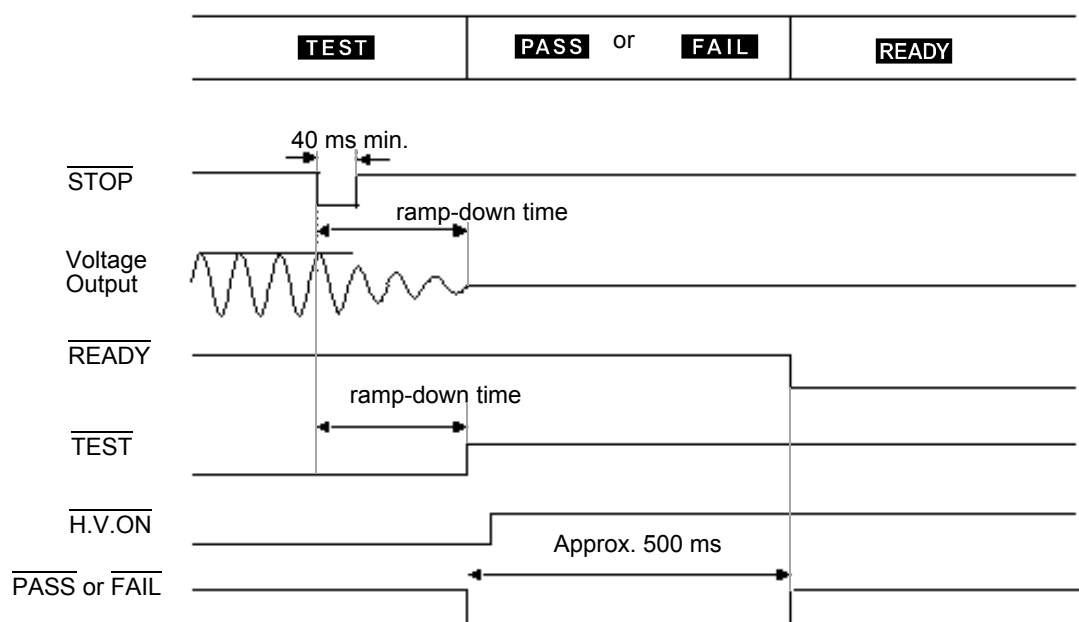

Note: When there is an evaluation result for a forced termination

### Insulation-resistance test (When the hold function is not used)

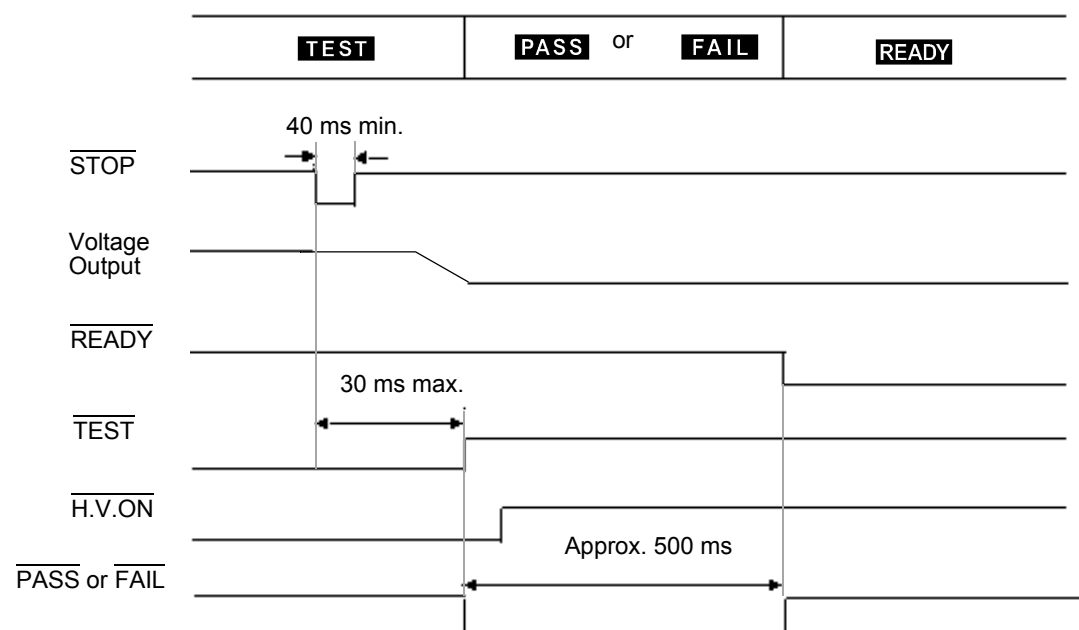

Note: When there is an evaluation result for a forced termination

### Changing during auto tests

This figure shows the switching timing chart of the instrument when it is in the auto-test mode. In this mode, withstand-voltage and insulation-resistance tests are conducted successively.

The instrument switches to the next test when the output-voltage value has dropped sufficiently. The  $\overline{\text{TEST}}$  signal remains at LOW level until a series of tests is completed.

#### Withstand-voltage test → Insulation-resistance test

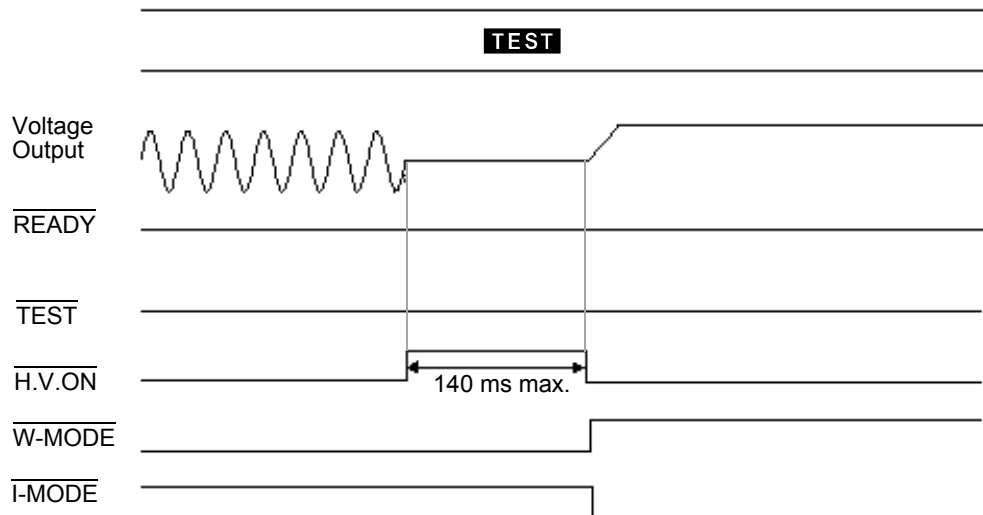

#### Insulation-resistance test → Withstand-voltage test

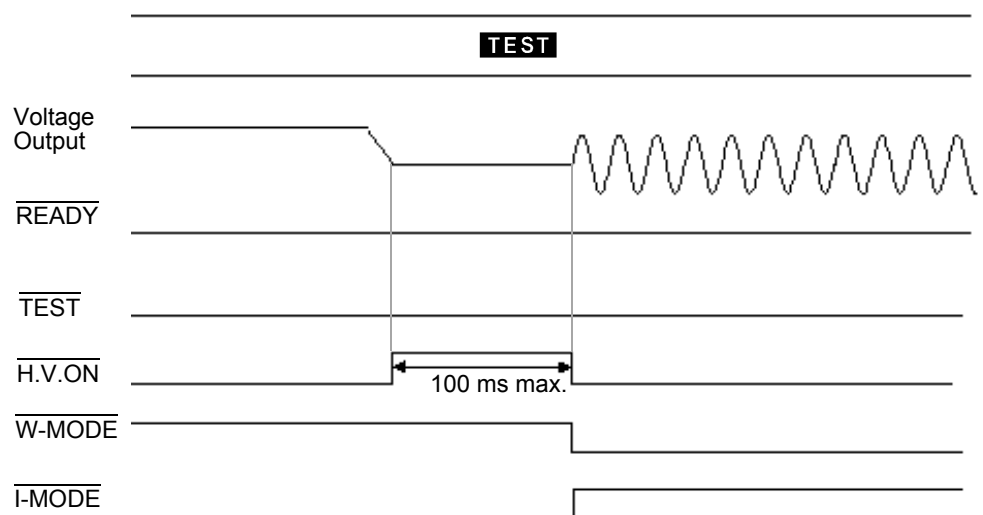

## 8.7 Adjusting the Buzzer sound

A buzzer sounds during PASS or FAIL screening and in the event of an error due to improper key operations. Two buzzer volume adjustment knobs are provided on the rear panel: one for PASS screening and one for FAIL screening. Volume adjustments can be made using the knobs.

Rear panel

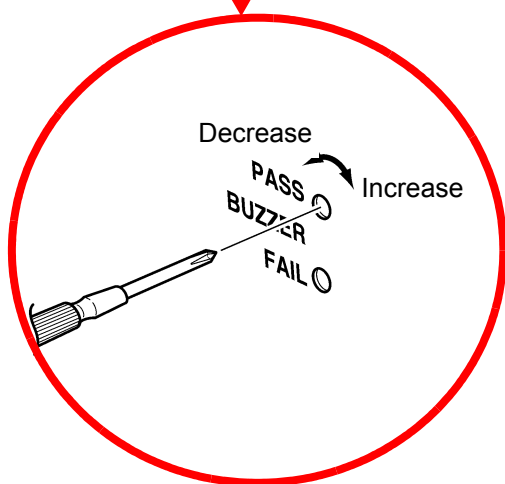
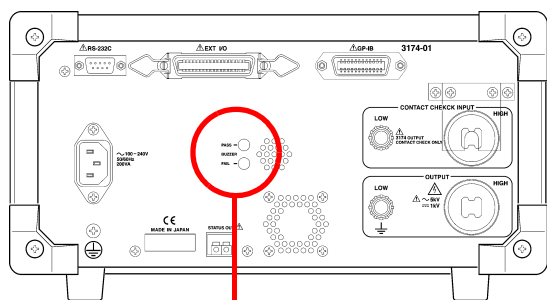

1. Check the **DANGER** lamp to make sure a voltage is not being output.
2. Using a Phillips-head screwdriver, adjust the volume adjustment knob.

Turn the knob clockwise: Increase the volume.  
Turn the knob counterclockwise: Decrease the volume.  
Turn fully to the right : OFF

### NOTE

- If an excessive force is placed on the volume adjustment knob, it may be fractured.
- The buzzer that sounds in the event of an error caused by improper key operations is at the same volume as the buzzer that sounds for FAIL screening.



# RS-232C/GP-IB Interface

## Chapter 9



**WARNING**

To increase test efficiency, this instrument can be controlled by external I/O or RS-232C and GP-IB and can start tests automatically. As a result, there is a danger of electric shock accidents. Measures to prevent people from coming near the instrument or the tested object unintentionally must be taken when starting the instrument automatically. Wear insulated gloves and confirm that automatic control is off before changing the tested object or touching the test lead and tested object directly.



**CAUTION**

- To avoid equipment failure, do not disconnect the communications cable while communications are in progress.
- Use a common ground for both the instrument and the computer. Using different ground circuits will result in a potential difference between the instrument's ground and the computer's ground. If the communications cable is connected while such a potential difference exists, it may result in equipment malfunction or failure.
- Before connecting or disconnecting any communications cable, always turn off the instrument and the computer. Failure to do so could result in equipment malfunction or damage.
- After connecting the communications cable, tighten the screws on the connector securely. Failure to secure the connector could result in equipment malfunction or damage.

This instrument can be controlled via the RS-232C and GP-IB.

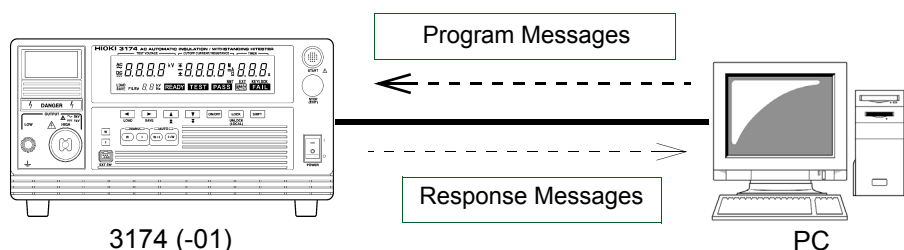

### Before Use

- The symbol shown below indicates that the following instructions are specific to the RS-232C or the GP-IB interface. Instructions without this symbol are for both the RS-232C and the GP-IB interface.

**GP-IB** : GP-IB only

**RS-232C** : RS-232C only

The GP-IB can only be used with the 3174-01 AC Automatic Insulation/Withstanding HiTester.

- Always make use of the connector screws to affix the GP-IB or RS-232C connectors.
- When issuing commands that contain data, make certain that the data is provided in the specified format.



- The IEEE 488.2-1987 common command (required) can be used.
- Complies with the following standard: Applicable standard IEEE 488.1-1987 <sup>\*1</sup>
- This instrument is designed with reference to the following standard: Reference standard IEEE 488.2-1987 <sup>\*2</sup>
- If the output queue becomes full, a query error is generated and the output queue is cleared. Therefore, clearing the output queue and query error output from the deadlocked condition <sup>\*3</sup> as defined in IEEE 488.2 is not supported.

\*1: ANSI/IEEE Standard 488.1-1987, IEEE Standard Digital Interface for Programmable Instrumentation

\*2: ANSI/IEEE Standard 488.2-1987, IEEE Standard Codes, Formats, Protocols, and Common Commands

\*3: The situation in which the input buffer and the output queue become full, so that processing cannot continue.

---



## 9.1 Specifications

### **RS-232C** RS-232C Specifications

Transfer method	Communications: Full duplex Synchronization: Start-stop synchronization
Baud rate	9600 bps/ 19200 bps
Data length	8 bits
Parity	none
Stop bit	1 bit
Message terminator (delimiter)	Receiving: CR + LF, CR Transmitting: CR + LF
Flow control	none
Electrical specification	Input voltage levels 5 to 15 V: ON; -15 to -5 V: OFF Output voltage levels 5 to 9 V : ON; -9 to -5 V : OFF (Load resistance: 3 k $\Omega$ to 7 k $\Omega$ )
Connector	RS-232C Interface Connector Pinout (Male 9-pin D-sub, with #4-40 attachment screws) The I/O connector is a DTE (Data Terminal Equipment) configuration Recommended cables: <ul style="list-style-type: none"> <li>• Model 9637 RS-232C Cable (For use with PC/AT connectors)</li> <li>• Model 9638 RS-232C Cable (for PC98 series)</li> </ul> See "9.2.1 Connecting the Connector" (p. 124)

### **GP-IB** GP-IB Specifications (3174-01 only)

SH1	All Source Handshake functions Yes
AH1	All Acceptor Handshake functions Yes
T6	Basic talker functions Yes Serial poll function Yes Talk-only mode No The talker cancel function with MLA (My Listen Address) Yes
L4	Basic listener functions Yes Listen-only mode No The listener cancel function with MTA (My Talk Address) Yes
SR1	All Service Request functions Yes
RL1	All Remote/Local functions Yes
PP0	Parallel Poll function No
DC1	All Device Clear functions Yes
DT0	Device Trigger functions No
C0	Controller functions No

## 9.2 Connection and Setting Procedures

### 9.2.1 Connecting the Connector



#### **! WARNING**

- Always turn both devices OFF when connecting and disconnecting an interface connector. Otherwise, an electric shock accident may occur.
- After connecting, always tighten the connector screws. The mounting screws must be firmly tightened or the instrument may not perform to specifications, or may even fail.

#### **! CAUTION**

To avoid damage to the instrument, do not short-circuit the terminal and do not input voltage to the terminal.

#### **RS-232C**

#### RS-232C connector

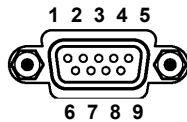

Male 9-pin D-sub  
#4-40 attaching screws

Connect the RS-232C cable.

When connecting the controller (DTE), prepare a cross cable that meets the specifications of the connector of the unit and the connector of the controller.

The I/O connector is a DTE (Data Terminal Equipment) configuration. This instrument uses pins 2, 3 and 5. Connect pins 7 and 8. The other pins are unconnected.

Pin No.	Signal name			Signal	Note
	Common	EIA	JIS		
1	DCD	CF	CD	Unused	Not connected
2	RxD	BB	RD	Receive Data	
3	TxD	BA	SD	Transmitted Data	
4	DTR	CD	ER	Data Terminal Ready	Not connected
5	GND	AB	SG	Signal Ground	
6	DSR	CC	DR	Unused	Not connected
7	RTS	CA	RS	Request to Send	Connect to 8
8	CTS	CB	CS	Unused	Connect to 7
9	RI	CE	CI	Unused	Not connected

#### **NOTE**

- The RS-232C GND (signal ground) is not isolated from the instrument's GND. If the connected device carries a potential, damage may result.  
Example countermeasures:
  - (1) Ground the connected device's COM terminal or GND.
  - (2) Use a commercially available optical communications unit to isolate the 3174 (-01) from the device.
- If the interlock function is enabled, the instrument will not accept communications.

**RS-232C**

When instrument is connected to the PC/AT (DOS/V) connector

**Use a crossover cable with female 9-pin D-sub connectors.**

Crossover Wiring

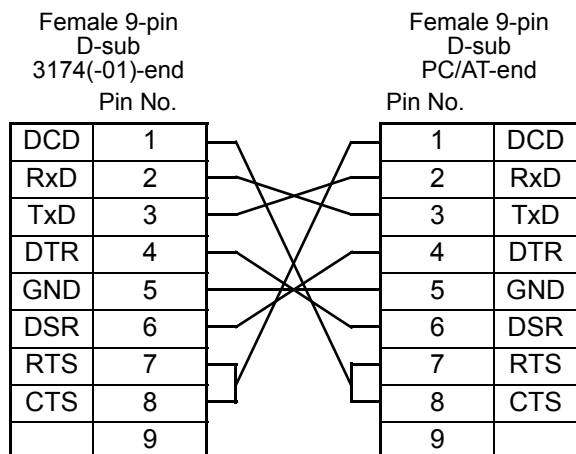

Recommended cable:

Hioki  
Model 9637 RS-232C  
Cable (1.8 m)

Using a desk top PC from the NEC PC9801 and PC9821 Series (excluding NX)

**Use a crossover cable with a female 9-pin D-sub and a male 25-pin D-sub connector.**

As the figure shows, RTS and CTS pins are shorted together and crossed to DCD in the other connector.

Crossover Wiring

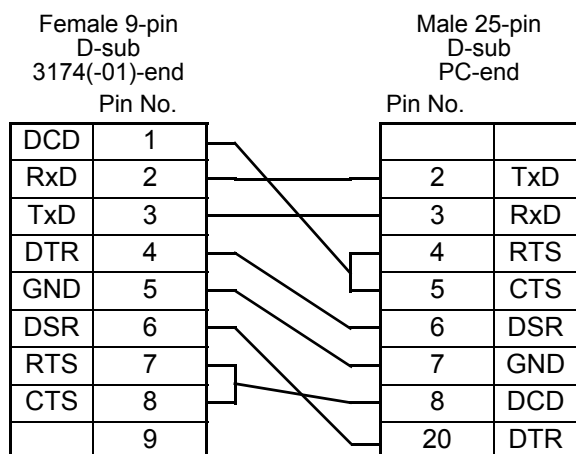

Recommended cable:

Hioki  
Model 9638 RS-232C  
Cable (1.8 m)

Note that the combination of a dual male 25-pin D-sub cable and a 9- to 25-pin adapter cannot be used.

**GP-IB**

GP-IB connector

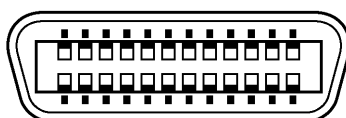

**Connect the GP-IB cable.**

Recommended cable:

Model 9151-02 GP-IB Connector Cable (2 m)

## 9.2.2 Setting the Communication Conditions

See "Appendix2 List of Optional Functions" (p. A4)

This function enables selection of the PC interface to be used (at the rear of the instrument). Make a selection from among RS-232C with a transmission speed of 9,600 bps, RS-232C with a transmission speed of 19,200 bps, and GP-IB. However, the GP-IB can only be used with the 3174-01.

1. (**READY** is lit)

Make sure the **READY** lamp is lit on the screen.

\* **READY** will not be displayed during the Double Action setting.

2.

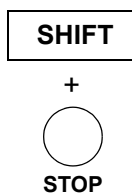

Press the **STOP** key while holding down the **SHIFT** key to display the optional screen (page 1).



3.

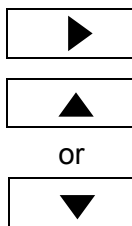

Press the **▶** key to move the flashing cursor to the position of page, and then press the **▲ / ▼** keys to display the optional screen (page 2).



4.



Press the **▶** key to move the flashing cursor to the position of interface.



5.

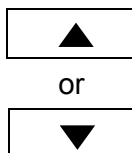

Press the **▲ / ▼** keys to select the mode.

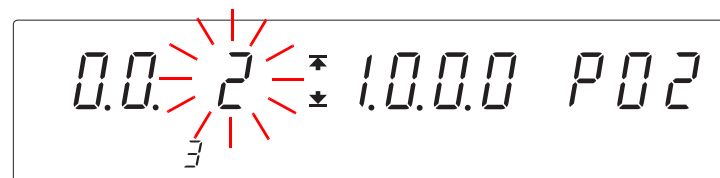

<Ex.> Select GP-IB

- 0: RS-232C (PC, 9600 bps) (Default setting)
- 1: RS-232C (PC, 19200 bps)
- 2: GP-IB (PC)

6.



When "2: GP-IB" is selected, press the ► key to move the flashing cursor to the position of GP-IB address.



7.



or



Press the ▲ / ▼ keys to select the mode.

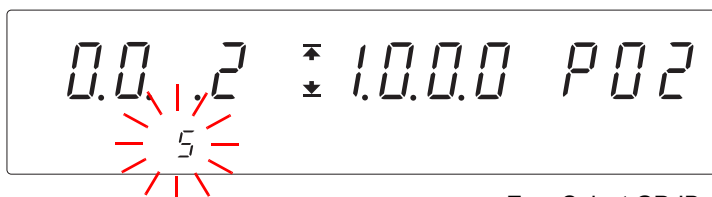

<Ex.> Select GP-IB Address 5

Setting range: 0 to 30 (Default setting: 3)

8.



+



STOP

Press the **STOP** key while holding down the **SHIFT** key to complete the setting value.

The instrument reverts to the READY state.

To continue to the setting for the next item, press the ► key.

### NOTE

- When both RS-232C and GP-IB are connected, signals without settings are ignored.
- When the interlock function is in operation, the instrument will not receive communication.

## 9.3 Communication Methods

Various messages are supported for controlling the instrument through the interfaces.

Messages can be either program messages, sent from a PC to the instrument, or response messages, sent from the instrument to a PC.

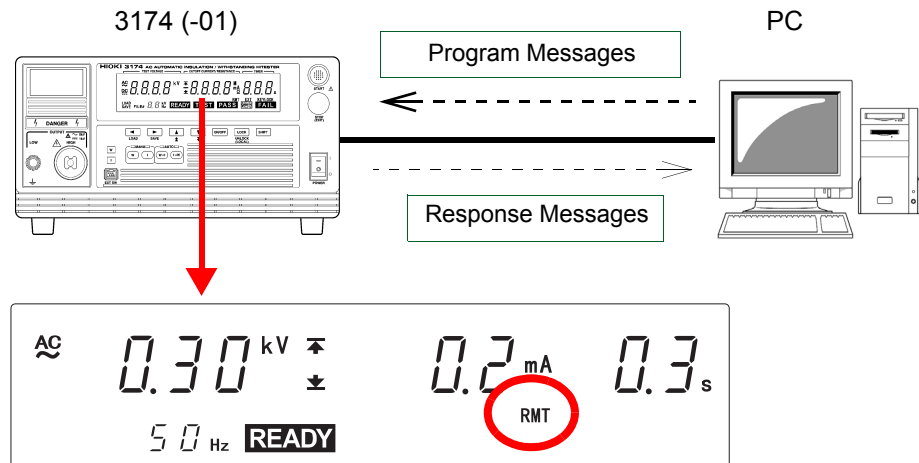

"RMT" lights up on the screen during communication, the instrument switch to the remote state.

In the remote state, operations besides **LOCAL** key are not possible. However, the following operations can be performed.

- Forced termination, HOLD release, complete the setting value, and saving and loading cancellation with the **STOP** key.
- Confirmation of optional functions with the **SHIFT** key + **STOP** key.

To cancel the remote condition (Communications) and restore the local condition, press the **LOCK (LOCAL)** key during the REMOTE condition.

Message types are further categorized as follows:

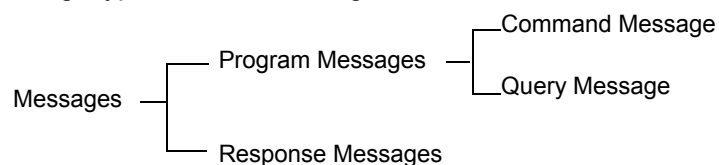



## Headers

Headers must always be prefixed to program messages.

### Command Program Headers

There are three types of commands: Simple, Compound and Standard.

- Headers for Simple Commands

This header type is a sequence of letters and digits

**\*ESE 0**

- Headers for Compound Commands

These headers consist of multiple simple command type headers separated by colons ":"

**:WITHstand:CLOWer**

- Headers for Standard Commands

This header type begins with an asterisk "\*", indicating that it is a standard command defined by IEEE 488.2.

**\*RST**

### Query Program Header

These commands are used to interrogate the instrument about the results of operations, measured values and the current states of instrument settings.

As shown by the following examples, a query is formed by appending a question mark "?" after a program header.

**:MODE?**

**:WITHstand:CLOWer?**

## **NOTE**

There is a need to add ":" to the front of the command except standard commands in the instrument.

## Message Terminators

This instrument recognizes the following message terminators:

### **GP-IB**

- LF
- CR+LF
- EOI
- LF with EOI

### **RS-232C**

- CR
- CR+LF

From the instrument's interface settings, the following can be selected as the terminator for response messages

### **GP-IB**

- LF with EOI (initial setting)
- LF with CR and EOI

### **RS-232C**

- CR+LF

See "9.2.2 Setting the Communication Conditions" (p. 126)



## Separators

### Header Separator

In a message containing multiple data items, commas are required to separate the data items from one another.

`:MODE  WITH`

### Data Separator

In a message containing multiple data items, commas are required to separate the data items from one another.

## Data Formats

The instrument uses character data and decimal numeric data, depending on the command.

### Character Data

Character data always begins with an alphabetic character, and subsequent characters may be either alphabetic or numeric. Character data is not case-sensitive, although response messages from the instrument are only upper case. Similar to Command Syntax, both long form and short form are acceptable.

`:WITHstand:CLOWer  ON`

### Decimal Numeric Data

Three formats are used for numeric data, identified as NR1, NR2 and NR3. Numeric values may be signed or unsigned. Unsigned numeric values are handled as positive values.

Values exceeding the precision handled by the instrument are rounded to the nearest valid digit.

NR1 ..... Integer data e.g.: +12, -23, 34

NR2 ..... Fixed-point data e.g.: +1.23, -23.45, 3.456

NR3 ..... Floating-point exponential representation data e.g.: +1.0E-2, -2.3E+4

The term "NRf format" includes all three of the above numeric decimal formats. The instrument accepts NRf format data.

The format of response data is specified for each command, and the data is sent in that format.

`:ESR0 10`

`:CONFigure:WITHstand:CLOWer 0.1`



The instrument does not fully support IEEE 488.2. As much as possible, please use the data formats shown in the Reference section.

Also, be careful to avoid constructing single commands that could overflow the input buffer or output queue.

## 9.3.2 Output Queue and Input Buffer

### Output Queue

Response messages are stored in the output queue until read by the controller. The output queue is also cleared in the following circumstances:

- Power on
- Device clear
- Query Error

The output queue capacity of the instrument is 120 bytes. If response messages overflow the buffer, a query error is generated and the output queue is cleared. Also, with GP-IB, if a new message is received while data remains in the output queue, the output queue is cleared and a query error is generated.

### Input Buffer

The output queue capacity of the instrument is 60 bytes. When the input buffer receives data that exceeds 60 bytes and becomes full, the GP-IB interface buss waits until buffer space becomes available.

RS-232C does not receive data that exceeds 60 bytes.

#### **NOTE**

Ensure that the no command ever exceeds 60 bytes.

---

### 9.3.3 Status Byte Register

This instrument implements the status model defined by IEEE 488.2 with regard to the serial poll function using the service request line.

The term "event" refers to any occurrence that generates a service request.

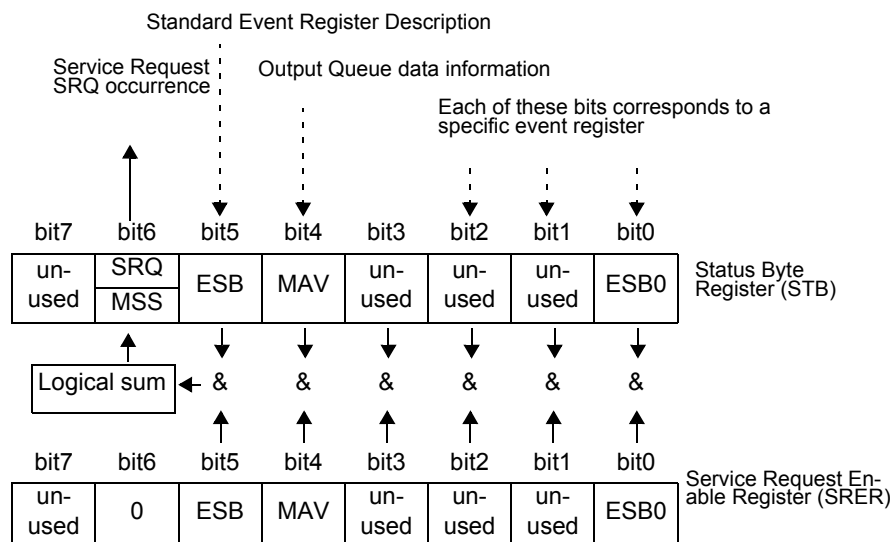

The Status Byte Register contains information about the event registers and the output queue. Required items are selected from this information by masking with the Service Request Enable Register. When any bit selected by the mask is set, bit 6 (MSS; the Master Summary Status) of the Status Byte Register is also set, which generates an SRQ (Service Request) message and dispatches a service request.

## Status Byte Register (STB)

During serial polling, the contents of the 8-bit Status Byte Register are sent from the instrument to the controller.

When any Status Byte Register bit enabled by the Service Request Enable Register has switched from 0 to 1, the MSS bit becomes 1. Consequently, the SRQ bit is set to 1, and a service request is dispatched.

The SRQ bit is always synchronous with service requests, and is read and simultaneously cleared during serial polling. Although the MSS bit is only read by an **\*STB?** query, it is not cleared until a clear event is initiated by the **\*CLS** command.

Bit 7	unused
Bit 6 SRQ	Set to 1 when a service request is dispatched.
MSS	This is the logical sum of the other bits of the Status Byte Register.
Bit 5 ESB	Standard Event Status (logical sum) bit This is logical sum of the Standard Event Status Register.
Bit 4 MAV	Message available Indicates that a message is present in the output queue.
Bit 3	unused
Bit 2	unused
Bit 1	unused
Bit 0 ESB0	Event Status (logical sum) bit 0 This is the logical sum of Event Status Register 0.

## Service Request Enable Register (SRER)

This register masks the Status Byte Register. Setting a bit of this register to 1 enables the corresponding bit of the Status Byte Register to be used.

## 9.3.4 Event Registers

### Standard Event Status Register (SESR)

The Standard Event Status Register is an 8-bit register.

If any bit in the Standard Event Status Register is set to 1 (after masking by the Standard Event Status Enable Register), bit 5 (ESB) of the Status Byte Register is set to 1.

The Standard Event Status Register is cleared in the following situations:

- When a **\*CLS** command is executed
- When an event register query (**\*ESR?**) is executed
- When the instrument is powered on

Bit 7	PON	Power-On Flag Set to 1 when the power is turned on, or upon recovery from an outage.
Bit 6	URQ	unused
Bit 5	CME	Command error. (The command to the message terminator is ignored.) This bit is set to 1 when a received command contains a syntactic or semantic error: <ul style="list-style-type: none"> <li>• Program header error</li> <li>• Incorrect number of data parameters</li> <li>• Invalid parameter format</li> <li>• Received a command not supported by the instrument</li> </ul>
Bit 4	EXE	Execution Error This bit is set to 1 when a received command cannot be executed for some reason. <ul style="list-style-type: none"> <li>• The specified data value is outside of the set range</li> <li>• The specified setting data cannot be set</li> </ul>
Bit 3	DDE	Device-Dependent Error This bit is set to 1 when a command cannot be executed due to some reason other than a command error, a query error or an execution error. <ul style="list-style-type: none"> <li>• Execution is impossible due to an internal instrument fault</li> </ul>
Bit 2	QYE	Query Error (the output queue is cleared) This bit is set to 1 when a query error is detected by the controller of the output queue. <ul style="list-style-type: none"> <li>• When an attempt has been made to read an empty output queue (GP-IB only)</li> <li>• When the data overflows the output queue</li> <li>• When data in the output queue is lost</li> </ul>
Bit 1	RQC	unused
Bit 0	OPC	unused

### Standard Event Status Enable Register (SESER)

Setting any bit of the Standard Event Status Enable Register to 1 enables access to the corresponding bit of the Standard Event Status Register.

#### Standard Event Status Register (SESR) and Standard Event Status Enable Register (SESER)

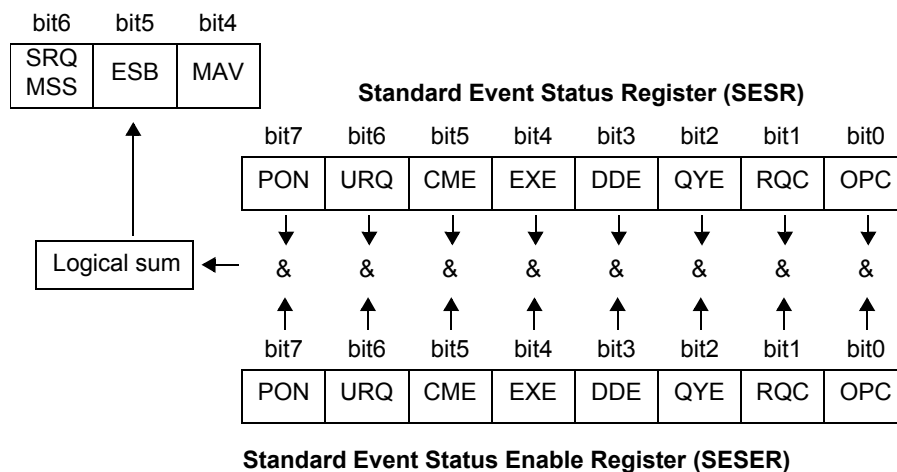

### Device-Specific Event Status Register (ESR0)

This instrument provides one event status register for controlling events. Each event register is an 8-bit register.

When any bit in one of these event status registers enabled by its corresponding event status enable register is set to 1, the following happens:

- For Event Status Register 0, bit 0 (ESB0) of the Status Byte Register (STB) is set to 1.

Event Status Register 0 is cleared in the following situations:

- When a **\*CLS** command is executed
- When an Event Status Register query (:ESR0?) is executed
- When the instrument is powered on

Event Status Register 0 (ESR0)	
Bit 7	unused
Bit 6	unused
Bit 5	unused
Bit 4	unused
Bit 3	EOM Test end bit
Bit 2	LFAIL Beyond the comparator lower-limit value
Bit 1	UFAIL Beyond the comparator upper-limit value
Bit 0	PASS Within the comparator range

### Event Status Register 0 (ESR0), and Event Status Enable Register 0 (ESER0)

#### Status Byte Register (STB)

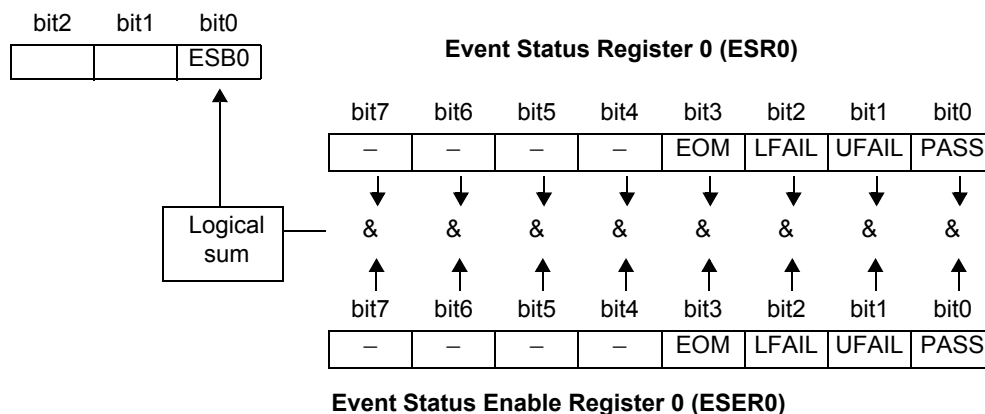

## Register Reading and Writing

Register	Read	Write
Status Byte Register	*STB?	–
Service Request Enable Register	*SRE?	*SRE
Standard Event Status Register	*ESR?	–
Standard Event Status Enable Register	*ESE?	*ESE
Event Status Register 0	:ESR0?	–
Event Status Enable Register 0	:ESE0?	:ESE0

## GP-IB Commands

The following commands can be used for performing interface functions.

Command	Description	
GTL	Go To Local	Cancels the Remote state and enters the Local state.
LLO	Local Lock Out	Disables all keys, including the <b>LOCAL</b> key.
DCL	Device CLear	Clears the input buffer and the output queue.
SDC	Selected Device Clear	Clears the input buffer and the output queue.

## 9.3.5 Initialization Items

1: initialized/ ×: not initialized

Initialization method Item	Power on	*RST command	Device clear	*CLS command
Device specific functions (ranges etc.)	×	1	×	×
Output queue	1	×	1	×
Input buffer	1	×	1	×
Status byte register	1	×	× <sup>*1</sup>	1 <sup>*2</sup>
Event register	1 <sup>*3</sup>	×	×	1
Enable register	1	×	×	×
Headers on/off	1	1	×	×

\*1: Only the MAV bit (bit 4) is cleared.

\*2: All bits except the MAV bit are cleared.

\*3: Except the PON bit (bit 7).

## 9.3.6 Local Function

During communications, “RMT” is lit to indicate the remote control state.

### To cancel the Remote state

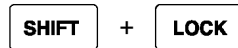

The “RMT” LED goes out.

### **NOTE**

Remote state cannot be cancelled when the GP-IB command Local Lock Out is set.



## 9.3.7 Command Reference List

### Common Commands (RS-232C/ GP-IB)

Command	Explanation	Ref page
<b>*CLS</b>	Clears the status byte register and the event registers.	144
<b>*ESR?</b>	Queries the contents of the standard event status register.	144
<b>*IDN?</b>	Queries manufacturer's name, model name, and software version.	145
<b>*RST</b>	Performs device initial setting.	145
<b>*TST?</b>	Requests execution of, and queries the result of, the self test.	145

### Specific Commands (RS-232C/ GP-IB)

Command	Explanation	Ref page
<b>:ESR0?</b>	Queries Event Status Register 0.	149
<b>:HEADer</b>	Enables and disables headers for the response messages.	150
<b>:HEADer?</b>	Queries whether or not headers on response messages are enabled.	150
<b>:MODE</b>	Sets the test mode.	151
<b>:MODE?</b>	Queries the test mode.	151
<b>:STATE?</b>	Queries the state.	151
<b>:START</b>	Starting a test.	153
<b>:STOP</b>	Forcibly ends a test and releases the hold state.	153
<b>:CONFigure:WITHstand?</b>	Queries the contents of the set-value for withstand-voltage tests.	154
<b>:CONFigure:WITHstand:KIND</b>	Sets the type of voltage for withstand-voltage tests.	155
<b>:CONFigure:WITHstand:KIND?</b>	Queries the type of voltage for withstand-voltage tests.	155
<b>:CONFigure:WITHstand:VOLTage</b>	Sets the test-voltage value for withstand-voltage tests.	156
<b>:CONFigure:WITHstand:VOLTage?</b>	Queries the test-voltage value for withstand-voltage tests.	156
<b>:CONFigure:WITHstand:CUPPer</b>	Sets the upper-limit test value for withstand-voltage tests.	156
<b>:CONFigure:WITHstand:CUPPer?</b>	Queries the upper-limit test value for withstand-voltage tests.	156
<b>:CONFigure:WITHstand:CLOWer</b>	Sets the lower-limit test value for withstand-voltage tests.	157
<b>:CONFigure:WITHstand:CLOWer?</b>	Queries the lower-limit test value for withstand-voltage tests.	157
<b>:CONFigure:WITHstand:TIMer</b>	Sets the test time for withstand-voltage tests.	157
<b>:CONFigure:WITHstand:TIMer?</b>	Queries the test time for withstand-voltage tests.	157
<b>:CONFigure:WITHstand:UTIMer</b>	Sets the ramp-up time for withstand-voltage tests.	158
<b>:CONFigure:WITHstand:UTIMer?</b>	Queries the ramp-up time for withstand-voltage tests.	158
<b>:CONFigure:WITHstand:DTIMer</b>	Sets the ramp-down time for withstand-voltage tests.	158
<b>:CONFigure:WITHstand:DTIMer?</b>	Queries the ramp-down time for withstand-voltage tests.	158
<b>:CONFigure:WITHstand:VINItial</b>	Sets the initial voltage for ramp-up for withstand-voltage tests.	159
<b>:CONFigure:WITHstand:VINItial?</b>	Queries the initial voltage for ramp-up for withstand-voltage tests.	159

Command	Explanation	Ref page
<code>:CONFigure:WITHstand:CNHI</code>	Sets the contact check upper-limit voltage for withstand-voltage tests.	159
<code>:CONFigure:WITHstand:CNHI?</code>	Queries the contact check upper-limit voltage for withstand-voltage tests.	159
<code>:CONFigure:WITHstand:CNLO</code>	Sets the contact check lower-limit voltage for withstand-voltage-tests.	160
<code>:CONFigure:WITHstand:CNLO?</code>	Queries the contact check lower-limit voltage for withstand-voltage tests.	160
<code>:WITHstand:CLOWer</code>	Enables and disables the lower-limit test value for withstand-voltage tests.	160
<code>:WITHstand:CLOWer?</code>	Queries the lower-limit test value enablement for withstand voltage tests.	160
<code>:WITHstand:TIMer</code>	Enables and disables the test time for withstand-voltage tests.	161
<code>:WITHstand:TIMer?</code>	Queries the test time enablement for withstand-voltage tests.	161
<code>:WITHstand:UTIMer</code>	Sets the ramp-up time ON/OFF for withstand-voltage tests.	162
<code>:WITHstand:UTIMer?</code>	Queries the ramp-up time ON/OFF for withstand-voltage tests.	162
<code>:WITHstand:DTIMer</code>	Sets the ramp-down time ON/OFF for withstand-voltage tests.	162
<code>:WITHstand:DTIMer?</code>	Queries the ramp-down time ON/OFF for withstand-voltage tests.	162
<code>:WITHstand:CNHI</code>	Sets the contact check upper-limit voltage ON/OFF for withstand-voltage tests.	163
<code>:WITHstand:CNHI?</code>	Queries the contact check upper-limit voltage ON/OFF for withstand-voltage tests.	163
<code>:WITHstand:CNLO</code>	Sets the contact check lower-limit voltage ON/OFF for withstand-voltage tests.	163
<code>:WITHstand:CNLO?</code>	Queries the contact check lower-limit voltage ON/OFF for withstand-voltage tests.	163
<code>:MEASure:RESult:WITHstand?</code>	Queries the withstand-voltage test result.	164
<code>:MEASure:WITHstand:VOLTage?</code>	Queries the measured voltage value for withstand-voltage tests.	164
<code>:MEASure:WITHstand:CURRent?</code>	Queries the measured current value for withstand-voltage tests.	165
<code>:MEASure:WITHstand:TIMer?</code>	Queries the test time elapsed for withstand-voltage tests.	165
<code>:MEMory:WITHstand:FILE?</code>	Queries the contents of the set-value memory for withstand-voltage tests.	166
<code>:MEMory:WITHstand:LOAD</code>	Loads the set-value memory for withstand-voltage tests.	166
<code>:MEMory:WITHstand:SAVE</code>	Saves set values for withstand-voltage tests in memory.	167
<code>:MEMory:WITHstand:CLear</code>	Clears the set-value memory for withstand-voltage tests.	167
<code>:CONFigure:INSulation?</code>	Queries the contents of the set-value for insulation-resistance tests.	167
<code>:CONFigure:INSulation:VOLTage</code>	Sets the test-voltage value for insulation-resistance tests.	168
<code>:CONFigure:INSulation:VOLTage?</code>	Queries the test-voltage value for insulation-resistance tests.	168
<code>:CONFigure:INSulation:RUPPer</code>	Sets the upper-limit test value for insulation-resistance tests.	168
<code>:CONFigure:INSulation:RUPPer?</code>	Queries the upper-limit test value for insulation-resistance tests.	168

Command	Explanation	Ref page
<code>:CONFigure:INSulation:RLOWer</code>	Sets the lower-limit test value for insulation-resistance tests.	169
<code>:CONFigure:INSulation:RLOWer?</code>	Queries the lower-limit test value for insulation-resistance tests.	169
<code>:CONFigure:INSulation:TIMer</code>	Sets the test time for insulation-resistance tests.	169
<code>:CONFigure:INSulation:TIMer?</code>	Queries the test time for insulation-resistance tests.	169
<code>:CONFigure:INSulation:DELAy</code>	Sets the delay time for insulation-resistance tests.	170
<code>:CONFigure:INSulation:DELAy?</code>	Queries the delay time for insulation-resistance tests.	170
<code>:INSulation:RUPPer</code>	Enables and disables the upper-limit test value for insulation-resistance tests.	170
<code>:INSulation:RUPPer?</code>	Queries the upper-limit test value enablement for insulation-resistance tests.	170
<code>:INSulation:TIMer</code>	Enables and disables the test time for insulation-resistance tests.	171
<code>:INSulation:TIMer?</code>	Queries the test time enablement for insulation-resistance tests.	171
<code>:INSulation:DELAy</code>	Sets the delay time ON/OFF for insulation-resistance tests.	171
<code>:INSulation:DELAy?</code>	Queries the delay time ON/OFF for insulation-resistance tests.	171
<code>:INSulation:CNHI</code>	Sets the contact check upper-limit voltage ON/OFF for insulation-resistance tests.	172
<code>:INSulation:CNHI?</code>	Queries the contact check upper-limit voltage ON/OFF for insulation-resistance tests.	172
<code>:INSulation:CNLO</code>	Sets the contact check lower-limit voltage ON/OFF for insulation-resistance tests.	172
<code>:INSulation:CNLO?</code>	Queries the contact check lower-limit voltage ON/OFF for insulation-resistance tests.	172
<code>:MEASure:RESult:INSulation?</code>	Queries the insulation-resistance test result.	173
<code>:MEASure:INSulation:VOLTage?</code>	Queries the measured voltage value for insulation-resistance tests.	173
<code>:MEASure:INSulation:RESis-tance?</code>	Queries the measured resistance value for insulation-resistance tests.	174
<code>:MEASure:INSulation:TIMer?</code>	Queries the test time elapsed for insulation-resistance tests.	174
<code>:MEMory:INSulation:FILE?</code>	Queries the content of data saved for insulation-resistance tests.	175
<code>:MEMory:INSulation:LOAD</code>	Loads data saved for insulation-resistance tests.	176
<code>:MEMory:INSulation:SAVE</code>	Saves data for insulation-resistance tests to memory files.	176
<code>:MEMory:INSulation:CLEar</code>	Clears the insulation-resistance test data saved to memory files.	176
<code>:SYStem:OPTion:P1</code>	Sets the optional functions 1	177
<code>:SYStem:OPTion:P1?</code>	Queries the optional functions 1	178
<code>:SYStem:OPTion:P2</code>	Sets the optional functions 2	179
<code>:SYStem:OPTion:P2?</code>	Queries the optional functions 2	180
<code>:SYStem:STATus</code>	Set status out	181
<code>:SYStem:STATus?</code>	Query status out	181
<code>:SYStem:LOCAL</code>	Cancel remote	182
<code>:SYStem:RESet</code>	Initialize to the default factory settings	182

**Common Commands (GP-IB only)**

Command	Explanation	Ref page
<b>*ESE</b>	Sets the standard event status enable register.	143
<b>*ESE?</b>	Queries the standard event status enable register.	143
<b>*SRE</b>	Sets the service request enable register.	147
<b>*SRE?</b>	Queries the service request enable register.	147
<b>*STB?</b>	Queries the status byte register.	147
<b>*WAI</b>	Waits until all execution is fully completed.	148

**Specific Commands (GP-IB only)**

Command	Explanation	Ref page
<b>:ESE0</b>	Sets event status enable register 0.	149
<b>:ESE0?</b>	Queries event status enable register 0.	149
<b>:TRANsmit:TERMinator</b>	Sets the data terminator for response messages.	182
<b>:TRANsmit:TERMinator?</b>	Queries the data terminator for response messages.	182

**Specific Commands (RS-232C only)**

Command	Explanation	Ref page
<b>:SYStem:ERRor?</b>	Queries RS-232C communication errors.	150

## 9.4 Message Reference

< >: Indicates the contents (character or numeric parameters) of the data portion of a message. Character parameters are returned as all capital letters.

### Numeric Parameters:

- NRf Number format may be any of NR1, NR2 and NR3
- NR1 Integer data (e.g.: +12, -23, 34)
- NR2 Fixed-point data (e.g.: +1.23, -23.45, 3.456)
- NR3 Floating-point exponential representation data (e.g.: +1.0E-2, -2.3E+4)

Shows the command description.

Shows the message syntax.  
Explains the command data or response message.

Describes the message.

Shows an example of an actual command application.  
(Normally described with HEADER ON, (except the HEADER command itself).)

### Read/Write the Standard Event Status Enable Register (SESER)

Syntax (Command) **\*ESE <0 to 255 (NR1)>**  
(Query) **\*ESE?**  
(Response) **<0 to 255 (NR1)>**

Explanation (Command) The SESER mask is set to the numerical value 0 to 255. The initial value (at power-on) is 0.  
(Query) The contents of the SESER, as set by the \*ESE command, are returned as an NR1 value (0 to 255).

128	64	32	16	8	4	2	1
bit 7	bit 6	bit 5	bit 4	bit 3	bit 2	bit 1	bit 0
PON	URQ	CME	EXE	DDE	QYE	RQC	OPC

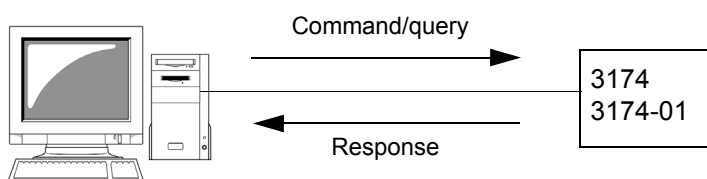

Example (Command) **\*ESE 36**  
(Sets bits 5 and 2 of SESER.)



## 9.4.1 Common Command

Messages specific to the RS-232C or GP-IB interface are identified by their corresponding symbols.

### Clearing of Status Byte Register and Related Queues (Except Output Queue)

- Syntax** (Command) **\*CLS**  
This clears event register compatible to the respective bytes of the status byte register. Status byte registered is also cleared.
- Error** If the data parameters are set after this command, a command error occurs.
- Note**  The output queue is not affected.
-  The output queue, the various enable registers and MAV bit 4 of the Status Byte Register are unaffected.

### Read and Clear the Standard Event Status Register (SESR)

- Syntax** (Query) **\*ESR?**  
Returns the contents of the SESR as an NR1 value from 0 to 255, then clears register contents.

(Response) **<0 to 255 (NR1)>**

128 bit 7	64 bit 6	32 bit 5	16 bit 4	8 bit 3	4 bit 2	2 bit 1	1 bit 0
PON	unused	CME	EXE	DDE	QYE	unused	unused

- Example** (Query) **\*ESR?**
- (Response) **32**  
Bit 5 of the SESR was set to 1.
- Note** A header is not added to the response message.

### Queries device ID.

**Syntax** (Query) **\*IDN?**  
Queries manufacturer's name, model name, and software version.

(Response) **<Manufacturer's name>,<Model name>,0,<Software version>**

**Example** (Query) **\*IDN?**

(Response) **HIOKI, 3174, 0, V1.00**

The Device ID is HIOKI, 3174, Model code 0 (standard model), software version 1.00.

**Note** A header is not added to the response message.

### Initialize Device

**Syntax** (Command) **\*RST**  
This resets all settings, apart from saved data, to the default factory settings.  
After initialization, the screen returns to the initial screen.

- Note**
- Send the **:SYStem:RESet** command if initialization of saved data is required.
  - The settings of the interface command "START", communication conditions (the PC interface, GP-IB address) and the inter-lock function cannot be reset.
  - The memory of the set values cannot be reset.
  - For items to be initialized, refer to "11.4 System Reset" (p. 201)

### Execute Self-Test and Query the Result

**Syntax** (Query) **\*TST?**  
Perform instrument self-test and return the result as numerical value 0 to 3.

(Response) **<0 to 3 (NR1)>**  
0..... No Errors  
1..... RAM Error  
2..... EEPROM Error  
3..... RAM Error and EEPROM Error

**Example** (Query) **\*TST?**

(Response) **1**  
A RAM error occurred.

**Error** The execution of this command in a state other than the READY state causes an execution error.

**Note** A header is not added to the response message.

## Sets and queries the Standard Event Status Enable Register (SESER)



**Syntax** (Command) **\*ESE <0 to 255 (NR1)>**  
 The SESER mask is set to the numerical value 0 to 255. The numerical value can be in NRf format, but any digits after the decimal point will be rounded.  
 The initial value (at power-on) is 0.

(Query) **\*ESE?**  
 The contents of the SESER, as set by the \*ESE command, are returned as an NR1 value (0 to 255).

(Response) **<0 to 255 (NR1)>**

128	64	32	16	8	4	2	1
bit 7	bit 6	bit 5	bit 4	bit 3	bit 2	bit 1	bit 0
PON	unused	CME	EXE	DDE	QYE	unused	unused

**Example** (Command) **\*ESE 36**  
 Sets bits 5 and 2 of SESER.

(Query) **\*ESE?**

(Response) **36**  
 SESER bits 5 and 2 have been set.

**Error** Execution error appears when setting is carried out in a format different from the NR1 numeric value format.

**Note** A header is not added to the response message.



## Sets and queries the Service Request Enable Register (SRER)



**Syntax** (Command) **\*SRE** <0 to 255 (NR1)>

The SRER mask is set to the numerical value 0 to 255.

The numerical value can be in NRf format, but any digits after the decimal point will be rounded. The values of bit 6 and the unused bit (bit 1, 2, 3 and 7) are ignored.

The value is initialized to 0 at power-on.

(Query) **\*SRE?**

The contents of the SRER, as set by the \*SRE command, are returned as an NR1 value (0 to 255). The values of bit 6 and the unused bit (bit 1, 2, 3 and 7) are always 0.

(Response) <0 to 255 (NR1)>

128 bit 7	64 bit 6	32 bit 5	16 bit 4	8 bit 3	4 bit 2	2 bit 1	1 bit 0
unused	0	ESB	MAV	unused	unused	unused	ESE0

**Example** (Command) **\*SRE 33**

Set SRER bits 0 and 5 to 1.

(Query) **\*SRE?**

(Response) **33**

SRER bits 0 and 5 have been set to 1.

**Error** Execution error appears when setting is carried out in a format different from the NR1 numeric value format.

**Note** A header is not added to the response message.

## Queries the Status Byte and MSS Bit



9

**Syntax** (Query) **\*STB?**

The contents of the STB are returned as an NR1 value (0 to 255).

(Response) <0 to 255 (NR1)>

128 bit 7	64 bit 6	32 bit 5	16 bit 4	8 bit 3	4 bit 2	2 bit 1	1 bit 0
unused	MSS	ESB	MAV	unused	unused	unused	ESE0

**Example** (Query) **\*STB?**

(Response) **16**

STB bit 4 has been set to 1.

**Note** A header is not added to the response message.

## Continuing Execution of Commands after Command Processing Ends



- Syntax** (Command) **\*WAI**  
The instrument goes into waiting state until the operation of the previous command has been completed.
- Error** If the data parameters are set after this command, a command error occurs.
- Note** The **\*WAI** command is accepted by the 9518-02 interface because it is a standard command as specified by IEEE-488.2 1987. However, since all of the commands specific to the 3174 (3174-01) are in any case sequential commands, using this **\*WAI** command never has any effect.

## 9.4.2 Device-Specific Commands

### Sets and queries Event Status Enable Register 0 (ESER0)



**Syntax** (Command) : **ESER0** <0 to 255 (NR1)>  
Sets the mask pattern in Event Status Enable Register 0 (ESER0) for the Event Status Register. The value is initialized to 0 at power-on.

(Query) : **ESER0?**  
Queries the mask pattern in Event Status Enable Register 0 (ESER0) for the Event Status Register.

(Response) <0 to 255 (NR1)>

128 bit 7	64 bit 6	32 bit 5	16 bit 4	8 bit 3	4 bit 2	2 bit 1	1 bit 0
unused	unused	unused	unused	EOM	LFAIL	UFAIL	PASS

**Error** Execution error appears when setting is carried out in a format different from the NR1 numeric value format.

### Query and Clear Event Status Register 0

**Syntax** (Query) : **ESR0?**  
Returns the event status register 0 (ESR0) setting and then clears that content.

(Response) <0 to 255 (NR1)>

**Example** (Query) : **ESR0?**

(Response) **4**  
Bit 2 of ESR0 is 1.

**Error** Execution error appears when setting is carried out in a format different from the NR1 numeric value format.

## Enables/disables and queries headers

- Syntax** (Command) **:HEADer <ON/ OFF>**  
Sets whether or not the instrument will prefix headers to its response messages.
- (Query) **:HEADer?**  
Queries whether or not the instrument will prefix headers to its response messages.
- (Response) **<ON/ OFF>**
- Example** (Command) **:HEADer ON**  
Headers are prefixed to response messages.
- (Query) **:HEADer?**
- (Response) **ON**  
A header is set to be added to response messages.
- Note**
- Execution error appears when setting other than ON/OFF is set.
  - If the PC interface settings are changed by setting optional functions when the power is turned ON, the header will be reset to OFF.

## Query of RS-232C Communication Error



- Syntax** (Query) **:SYStem:ERRor?**  
Returns the RS-232C communication error register content and then clears that content.
- (Response) **<0 to 3 (NR1)>**
- | 128<br>bit 7 | 64<br>bit 6 | 32<br>bit 5 | 16<br>bit 4 | 8<br>bit 3 | 4<br>bit 2 | 2<br>bit 1        | 1<br>bit 0                     |
|--------------|-------------|-------------|-------------|------------|------------|-------------------|--------------------------------|
| unused       | unused      | unused      | unused      | unused     | unused     | Time out<br>error | Overrun error<br>Framing error |
- Example** (Query) **:SYStem:ERRor?**
- (Response) **2**  
A time out error has occurred.

## Sets and Queries the test mode

**Syntax** (Command) **:MODE** <MWITH/ MINS/ AWI/ AIW>  
In the READY state, sets the test mode.

(Query) **:MODE?**  
In the READY state, queries the test mode.

(Response) <MWITH/ MINS/ AWI/ AIW>  
MWITH.....Withstand-voltage mode  
MINS.....Insulation-resistance mode  
AWI.....Withstand-voltage → Insulation-resistance  
automatic test mode  
AIW.....Insulation-resistance → Withstand-voltage  
automatic test mode

**Example** (Command) **:MODE AWI**  
Set to insulation-resistance automatic test mode.

(Query) **:MODE?**

(Response) **AWI**  
Insulation-resistance automatic test mode.

- Error**
- The execution of this command in a state other than the READY state (including double action), the test setting state, the optional screen and the saving/loading screen causes an execution error.
  - When the test time for the withstand-voltage and insulation-resistance tests is set to OFF, an execution error will occur when AWI or AIW setting is chosen.

## Queries the state

**Syntax** (Query) **:STATe?**  
Queries the state.

(Response) <WPASS/ IPASS/ WUFAIL/ IUFAIL/ WLFAIL/ ILFAIL/ WREADY/ IREADY/ WTEST/ ITEST/ NULL>  
WPASS.....Withstand-voltage mode PASS  
IPASS.....Insulation-resistance mode PASS  
WUFAIL.....Withstand-voltage mode UPPER FAIL  
IUFAIL.....Insulation-resistance mode UPPER FAIL  
WLFAIL.....Withstand-voltage mode LOWER FAIL  
ILFAIL.....Insulation-resistance mode LOWER FAIL  
WREADY.....Withstand-voltage mode READY  
IREADY.....Insulation-resistance mode READY  
WTEST.....Withstand-voltage mode TEST  
ITEST.....Insulation-resistance mode TEST  
NULL.....Others

**Example** (Query) **:STATe?**

(Response) **WREADY**  
In the withstand-voltage mode READY state.

### Queries the state

---

---

- Note**
- In the optional functions, if the Continuous Test mode is set to "1: Test continues when **FAIL** appears", the continuation of a test during FAIL will return a WTEST or ITEST.
  - If the test is forcibly stopped with no judgment delivered, the instrument returns a NULL value.

## Starting a test

**Syntax** (Command) : **START**  
Starts a test in the READY state.

**Example** : **START**

- Error**
- The execution of this command in a state other than the READY state or "test setting state" causes an execution error.
  - In the optional functions, if the interface command START is invalid, the execution of this command causes an execution error.
  - Note that an execution error occurs when double action is set to "1: ON" on the optional function setting screen.
  - In the optional function setting, an execution error will occur if "output voltage limit value < test voltage value" is set for the withstand-voltage test's output voltage limit.

- Note**
- To start a test using this command, set "START" for the interface command to "Start command valid", which is an optional function setting.
  - In this command, set Momentary Out in the optional function setting to "0:OFF". At "1:ON", the test forcibly stops immediately after test starts.

See "9.5 Interface Command "START"" (p. 188)

## Forcibly ends a test and releases the hold state

**Syntax** (Command) : **STOP**  
In the TEST state, forcibly ends a test. Furthermore, releases the Hold function and returns to the READY state.  
However, in the optional functions, when "FAIL Mode Function" is set to ON, the Hold function cannot be disabled by this command.  
See "6.5 Limiting the FAIL Hold Cancellation (FAIL mode)" (p. 90)

**Example** : **STOP**

- Error**
- In the optional functions, when "FAIL Mode Function" is set to ON, an execution error will occur if the instrument is in the FAIL Hold Mode.

### Queries the contents of the set-value for withstand-voltage tests

<b>Syntax</b>	(Query)	<b>:CONFigure:WITHstand?</b> Queries the contents of the set-value for withstand-voltage tests.
	(Response)	<p>&lt;Test-voltage&gt;, &lt;Current upper-limit value&gt;, &lt;Current lower-limit value&gt;, &lt;Test time&gt;, &lt;Test frequency&gt;, &lt;Ramp-up time&gt;, &lt;Ramp-down time&gt;, &lt;initial voltage for ramp-up&gt;, &lt;contact check upper-limit voltage&gt;, &lt;contact check lower-limit voltage&gt;</p> <p>Test-voltage..... 0.20 to 5.00 (NR2, unit: kV)  Current upper-limit value..... 0.1 to 20.0 (NR2, unit: mA)  Current lower-limit value ..... 0.1 to 19.9 (NR2, unit: mA)  0: OFF</p> <p>Test time..... 0.3 to 999 (NR1/NR2, unit: s)  0: OFF</p> <p>Test frequency..... AC50 / AC60 (unit: Hz)  Ramp-up time ..... 0.1 to 99.9 (NR2, unit: s)  0: OFF</p> <p>Ramp-down time ..... 0.1 to 99.9 (NR2, unit: s)  0: OFF</p> <p>initial voltage for ramp-up..... 0.0 to 1.0 (NR2)  contact check upper-limit voltage. 0.20 to 5.00 (NR2, unit: kV)  0: OFF</p> <p>contact check lower-limit voltage . 0.20 to 5.00 (NR2, unit: kV)  0: OFF</p>
<b>Example</b>	(Query)	<b>:CONFigure:WITHstand?</b>
	(Response)	<p><b>1.50, 5.0, 0.1, 30.0, AC50, 10.0, 5.0, 0.2, 2.00, 1.00</b></p> <p>The settings for withstand test are as follows.</p> <p>Test-voltage..... 1.5 kV  Current upper-limit value ..... 5.0 mA  Current lower-limit value..... 0.1 mA  Test time set value ..... 30.0 s  Test frequency..... 50 Hz AC  Ramp-up time ..... 10.0 s  Ramp-down time ..... 5.0 s  initial voltage for ramp-up ..... 0.2 kV  contact check upper-limit voltage ... 2.0 kV  contact check lower-limit voltage.... 1.0 kV</p>



---

**Sets and Queries the type of voltage for withstand-voltage tests**

---

**Syntax** (Command) **:CONFigure:WITHstand:KIND <AC50 / AC60>**  
Sets the type of voltage for withstand-voltage tests in the READY state.

(Query) **:CONFigure:WITHstand:KIND?**  
Queries the type of voltage for withstand-voltage tests in the READY state.

(Response) **<AC50 / AC60>**  
AC50 .....50 Hz AC  
AC60 .....60 Hz AC

**Example** (Command) **:CONFigure:WITHstand:KIND AC50**  
Sets the test frequency at 50 Hz AC.

(Query) **:CONFigure:WITHstand:KIND?**

(Response) **AC50**  
The test frequency is set at 50 Hz AC.

**Error** The execution of this command in a state other than the READY state or "test setting state" causes an execution error.

### Sets and Queries the test-voltage value for withstand-voltage tests

- Syntax**
- (Command) **:CONFigure:WITHstand:VOLTage <0.20 to 5.00 (NRf)>**  
Sets the test-voltage value (unit: kV) for withstand-voltage tests in the READY state.
- (Query) **:CONFigure:WITHstand:VOLTage?**  
Queries the test-voltage value (unit: kV) for withstand-voltage tests.
- (Response) **<0.20 to 5.00 (NR2)>**
- Example**
- (Command) **:CONFigure:WITHstand:VOLTage 1.00**  
Sets the test-voltage value for withstand-voltage tests at 1.00 kV.
- (Query) **:CONFigure:WITHstand:VOLTage?**
- (Response) **1.00**  
The test-voltage value is 1.00 KV.
- Error**
- The execution of this command in a state other than the READY state or "test setting state" causes an execution error. However, in the optional function mode, when the interface command "START" is valid, the voltage during testing can be changed. If the interface command "START" is invalid, the execution of this command causes an execution error.
- Note**
- To change the voltage during test, set "START" for the interface command to "Start command valid", which is an optional function setting.
  - In the optional function mode, when the output voltage is restricted, a value higher than the restricted value cannot be set.

### Sets and Queries the upper-limit test value for withstand-voltage tests

- Syntax**
- (Command) **:CONFigure:WITHstand:CUPPer <0.1 to 20.0 (NRf)>**  
Sets the upper-limit test value (unit: mA) for withstand-voltage tests, in the READY state.
- (Query) **:CONFigure:WITHstand:CUPPer?**  
Queries the upper-limit test value (unit: mA) for withstand-voltage tests.
- <0.1 to 20.0 (NR2)>**
- Example**
- (Command) **:CONFigure:WITHstand:CUPPer 5.0**  
Sets the upper-limit test value for withstand-voltage tests to 5.0 mA.
- (Query) **:CONFigure:WITHstand:CUPPer?**
- (Response) **5.0**  
The upper-limit test value is 5.0 mA.
- Error**
- The execution of this command in a state other than the READY state or "test setting state" causes an execution error.
  - When the lower limit of the withstand-voltage test is set to ON, an execution error will occur when "upper limit test value  $\leq$  lower limit test value" is set.

## Sets and Queries the lower-limit test value for withstand-voltage tests

- Syntax** (Command) `:CONFigure:WITHstand:CLOWer <0.1 to 19.9 (NRf)>`  
Sets the lower-limit test value (unit: mA) for withstand-voltage tests, in the READY state.
- (Query) `:CONFigure:WITHstand:CLOWer?`  
Queries the lower-limit test value (unit: mA) for withstand-voltage tests.  
`<0.1 to 19.9 (NR2)>`
- Example** (Command) `:CONFigure:WITHstand:CLOWer 0.1`  
Sets the lower-limit test value for withstand-voltage tests to 0.1 mA.
- (Query) `:CONFigure:WITHstand:CLOWer?`
- (Response) `0.1`  
The lower-limit test value is 0.1 mA.
- Error**
- The execution of this command in a state other than the READY state or "test setting state" causes an execution error.
  - When the lower limit of the withstand-voltage test is set to ON, an execution error will occur when "upper limit test value  $\leq$  lower limit test value" is set.

## Sets and Queries the test time for withstand-voltage tests

- Syntax** (Command) `:CONFigure:WITHstand:TIMer <0.3 to 999 (NRf)>`  
Sets the test time (unit: s) for withstand-voltage tests, in the READY state.
- (Query) `:CONFigure:WITHstand:TIMer?`  
Queries the test time (unit: s) for withstand-voltage tests.
- (Response) `<0.3 to 999 (NR1/NR2)>`
- Example** (Command) `:CONFigure:WITHstand:TIMer 30.0`  
Sets the test time for withstand-voltage tests to 30.0 s.
- (Query) `:CONFigure:WITHstand:TIMer?`
- (Response) `30.0`  
The test time is set to 30.0 s.
- Error** The execution of this command in a state other than the READY state or "test setting state" causes an execution error.

### Sets and Queries the ramp-up time for withstand-voltage tests

<b>Syntax</b>	(Command)	<b>:CONFigure:WITHstand:UTIMer</b> <0.1 to 99.9 (NRf)> Sets the ramp-up time (unit: s) for withstand-voltage tests in the READY state.
	(Query)	<b>:CONFigure:WITHstand:UTIMer?</b> Queries the ramp-up time (unit: s) for withstand-voltage tests.
	(Response)	<0.1 to 99.9 (NR2)>
<b>Example</b>	(Command)	<b>:CONFigure:WITHstand:UTIMer 10.0</b> Sets the ramp-up time for withstand-voltage tests at 10.0 s.
	(Query)	<b>:CONFigure:WITHstand:UTIMer?</b>
	(Response)	<b>10.0</b> The set ramp-up time is 10.0 s.
<b>Error</b>	The execution of this command in a state other than the READY state or "test setting state" causes an execution error.	

### Sets and Queries the ramp-down time for withstand-voltage tests

<b>Syntax</b>	(Command)	<b>:CONFigure:WITHstand:DTIMer</b> <0.1 to 99.9 (NRf)> Sets the ramp-down time (unit: s) for withstand-voltage tests in the READY state.
	(Query)	<b>:CONFigure:WITHstand:DTIMer?</b>
	(Response)	<0.1 to 99.9 (NR2)> Queries the ramp-down time (unit: s) for withstand-voltage tests.
<b>Example</b>	(Command)	<b>:CONFigure:WITHstand:DTIMer 5.0</b> Sets the ramp-down time for withstand-voltage tests at 5.0 s.
	(Query)	<b>:CONFigure:WITHstand:DTIMer?</b>
	(Response)	<b>5.0</b> The set ramp-down time is 5.0 s.
<b>Error</b>	The execution of this command in a state other than the READY state or "test setting state" causes an execution error.	

### Sets and Queries the initial voltage for ramp-up for withstand-voltage tests

- Syntax**
- (Command) **:CONFigure:WITHstand:VInitial <0.0 to 1.0 (NR2)>**  
Set the initial voltage for the withstand test voltage ramp-up as a proportion of the test voltage.
- (Query) **:CONFigure:WITHstand:VInitial?**  
Queries the initial voltage for ramp-up for withstand-voltage tests.
- (Response) **<0.0 to 1.0 (NR2)>**
- Example**
- (Command) **:CONFigure:WITHstand:VInitial 0.5**  
Set the ramp-up initial voltage as 0.5 times that of the test voltage.
- (Query) **:CONFigure:WITHstand:VInitial?**
- (Response) **0.5**  
Ramp-up initial voltage is test voltage x 0.5.
- Error**
- The execution of this command in a state other than the READY state or "test setting state" causes an execution error.
  - Execution error appears when value other than 0 to 1.0 is set.

### Sets and Queries the contact check upper-limit voltage for withstand-voltage tests

- Syntax**
- (Command) **:CONFigure:WITHstand:CNHI <0.20 to 5.00 (NRf)>**  
Sets the contact check upper-limit voltage for withstand-voltage tests in the READY state.
- (Query) **:CONFigure:WITHstand:CNHI?**  
Queries the contact check upper-limit voltage for withstand-voltage tests.
- (Response) **<0.20 to 5.00 (NR2)>**
- Example**
- (Command) **:CONFigure:WITHstand:CNHI 1.00**  
Sets the contact check upper-limit voltage for withstand-voltage tests at 1.00 kV.
- (Query) **:CONFigure:WITHstand:CNHI?**
- (Response) **1.00**  
The contact check upper-limit voltage for withstand-voltage tests is set to 1.00 kV.
- Error**
- The execution of this command in a state other than the READY state or "test setting state" causes an execution error.

### Sets and Queries the contact check lower-limit voltage for withstand-voltage tests

<b>Syntax</b>	(Command)	<b>:CONFigure:WITHstand:CNLO &lt;0.20 to 5.00 (NRf)&gt;</b> Sets the contact check lower-limit voltage for withstand-voltage tests in the READY state.
	(Query)	<b>:CONFigure:WITHstand:CNLO?</b> Queries the contact check lower-limit voltage for withstand-voltage tests.
	(Response)	<b>&lt;0.20 to 5.00 (NR2)&gt;</b>
<b>Example</b>	(Command)	<b>:CONFigure:WITHstand:CNLO 1.00</b> Sets the contact check lower-limit voltage for withstand-voltage tests at 1.00 kV.
	(Query)	<b>:CONFigure:WITHstand:CNLO?</b>
	(Response)	<b>1.00</b> The contact check lower-limit voltage for withstand-voltage tests is set to 1.00 kV.
<b>Error</b>	The execution of this command in a state other than the READY state or "test setting state" causes an execution error.	

### Enables/disables and Queries the lower-limit test value for withstand-voltage tests

<b>Syntax</b>	(Command)	<b>:WITHstand:CLOWer &lt;ON/ OFF&gt;</b> Enables and disables the lower-limit test value for withstand-voltage tests, in the READY state.
	(Query)	<b>:WITHstand:CLOWer?</b> Queries the lower-limit test value enablement for withstand-voltage tests.
	(Response)	<b>&lt;ON/ OFF&gt;</b>
<b>Example</b>	(Command)	<b>:WITHstand:CLOWer ON</b> Enables the lower-limit test value for a withstand-voltage test.
	(Query)	<b>:WITHstand:CLOWer?</b>
	(Response)	<b>ON</b> The lower-limit test value for the withstand-voltage tests is set to ON.
<b>Error</b>	<ul style="list-style-type: none"> <li>• The execution of this command in a state other than the READY state or "test setting state" causes an execution error.</li> <li>• When the upper limit and lower limit values of the withstand-voltage test are set as "upper limit test value <math>\leq</math> lower limit test value", an execution error will occur when the lower limit of the withstand-voltage test is set to ON.</li> </ul>	

---

---

**Enables/disables and Queries the test time for withstand-voltage tests**

---

---

**Syntax** (Command) **:WITHstand:TIMer <ON/ OFF>**  
Enables and disables the test time for withstand-voltage tests, in the READY state.

(Query) **:WITHstand:TIMer?**  
Queries the test time enablement for withstand-voltage tests.

(Response) **<ON/ OFF>**

**Example** (Command) **:WITHstand:TIMer ON**  
Enables the test time for a withstand-voltage tests.

(Query) **:WITHstand:TIMer?**

(Response) **ON**  
The test time for the withstand-voltage tests is set to ON.

**Error** The execution of this command in a state other than the READY state or "test setting state" causes an execution error.

**Enables/disables and Queries the ramp-up time for withstand-voltage tests**

---

---

- Syntax** (Command) **:WITHstand:UTIMer <ON/ OFF>**  
Sets the ramp-up time ON/OFF for withstand-voltage tests in the READY state.
- (Query) **:WITHstand:UTIMer?**  
Queries the ramp-up time ON/OFF for withstand-voltage tests.
- (Response) **<ON/ OFF>**
- Example** (Command) **:WITHstand:UTIMer ON**  
Sets the ramp-up time for the withstand-voltage tests to ON.
- (Query) **:WITHstand:UTIMer?**
- (Response) **ON**  
The ramp-up time for the withstand-voltage tests is set to ON.
- Error** The execution of this command in a state other than the READY state or "test setting state" causes an execution error.

**Enables/disables and Queries the ramp-down time for withstand-voltage tests**

---

---

- Syntax** (Command) **:WITHstand:DTIMer <ON/ OFF>**  
Sets the ramp-down time ON/OFF for withstand-voltage tests in the READY state.
- (Query) **:WITHstand:DTIMer?**  
Queries the ramp-down time ON/OFF for withstand-voltage tests.
- (Response) **<ON/ OFF>**
- Example** (Command) **:WITHstand:DTIMer ON**  
Sets the ramp-down time for the withstand-voltage tests to ON.
- (Query) **:WITHstand:DTIMer?**
- (Response) **ON**  
The ramp-down time for the withstand-voltage tests is set to ON.
- Error** The execution of this command in a state other than the READY state or "test setting state" causes an execution error.
-



### Enables/disables and Queries the contact check upper-limit voltage for withstand-voltage tests

- Syntax** (Command) **:WITHstand:CNHI <ON/ OFF>**  
Sets the contact check upper-limit voltage ON/OFF for withstand-voltage tests in the READY state.
- (Query) **:WITHstand:CNHI?**  
Queries the contact check upper-limit voltage ON/OFF for withstand-voltage tests.
- (Response) **<ON/ OFF>**
- Example** (Command) **:WITHstand:CNHI ON**  
Sets the contact check upper-limit voltage for the withstand-voltage tests to ON.
- (Query) **:WITHstand:CNHI?**
- (Response) **ON**  
The contact check upper-limit voltage for the withstand-voltage tests is set to ON.
- Error** The execution of this command in a state other than the READY state or "test setting state" causes an execution error.

### Enables/disables and Queries the contact check lower-limit voltage for withstand-voltage tests

- Syntax** (Command) **:WITHstand:CNLO <ON/ OFF>**  
Sets the contact check lower-limit voltage ON/OFF for withstand-voltage tests in the READY state.
- (Query) **:WITHstand:CNLO?**  
Queries the contact check lower-limit voltage ON/OFF for withstand-voltage tests.
- (Response) **<ON/ OFF>**
- Example** (Command) **:WITHstand:CNLO ON**  
Sets the contact check lower-limit voltage for the withstand-voltage tests to ON.
- (Query) **:WITHstand:CNLO?**
- (Response) **ON**  
The contact check lower-limit voltage for the withstand-voltage tests is set to ON.
- Error** The execution of this command in a state other than the READY state or "test setting state" causes an execution error.

### Queries the withstand-voltage test result

<b>Syntax</b>	(Query)	<b>:MEASure:RESult:WITHstand?</b> Queries the results of the preceding test. Returns the determination and valid values at termination of the preceding test. The test results are updated upon termination of a new test.
	(Response)	<b>&lt;Withstand-voltage test measured voltage value&gt;</b> , <b>&lt;Measured current value&gt;</b> , <b>&lt;Test time elapsed&gt;</b> , <b>&lt;Determination&gt;</b> , <b>&lt;Types of timers&gt;</b>  Withstand-voltage test measured voltage value .....(NR2, unit: kV) Measured current value ..(NR2, unit: mA) Test time elapsed .....(NR2, unit: s) Determination.....PASS/ UFAIL/ LFAIL/ ULFAIL/ OFF PASS : PASS UFAIL : UPPER-FAIL LFAIL : LOWER-FAIL ULFAIL : UPPER-LOWER-FAIL OFF : Others (no determination) Types of timers.....0/ 1/ 2 (NR1) 0: test time 1: ramp-up time 2: ramp-down time
<b>Example</b>	(Query)	<b>:MEASure:RESult:WITHstand?</b>
	(Response)	<b>1.00, 2.00, 30.0, PASS, 0</b>  Withstand-voltage test result Measured voltage value: 1.00 kV; Measured current value: 2.00 mA; Test time elapsed: 30.0 s; Determination: PASS; Types of timers: test time

- Note**
- When the instrument indicates “- -” for a current value, the command’s current measurement value will return 99.99 (10 mA-range) / 99.9 (20 mA-range).
  - Contact error type will not return.

### Queries the measured voltage value for withstand-voltage tests

<b>Syntax</b>	(Query)	<b>:MEASure:WITHstand:VOLTage?</b> Queries the measured voltage value (unit: kV) for withstand-voltage tests.
	(Response)	<b>&lt;Measured voltage value for withstand-voltage tests (NR2)&gt;</b>
<b>Example</b>	(Query)	<b>:MEASure:WITHstand:VOLTage?</b>
	(Response)	<b>1.00</b> The measured voltage value is 1.00 kV.
<b>Error</b>		The execution of this command in a state other than the TEST state causes an execution error.

### Queries the measured current value for withstand-voltage tests

- Syntax** (Query) **:MEASure:WITHstand:CURRent?**  
 Queries the measured current value (unit: mA) for withstand-voltage tests.
- (Response) **<Measured current value for withstand-voltage tests (NR2)>**
- Example** (Query) **:MEASure:WITHstand:CURRent?**
- (Response) **2.00**  
 The measured current value is 2.00 mA.
- Error** The execution of this command in a state other than the TEST state causes an execution error.

### Queries the test time elapsed for withstand-voltage tests

- Syntax** (Query) **:MEASure:WITHstand:TIMer?**  
 Queries the test time elapsed (unit: s) for withstand-voltage tests.
- (Response) **<Withstand-voltage test time elapsed>, <Types of timers>**  
 Withstand-voltage test time elapsed (NR2, unit: s)  
 Types of timers .....0/ 1/ 2 (NR1)  
   0: test time  
   1: ramp-up time  
   2: ramp-down time
- Example** (Query) **:MEASure:WITHstand:TIMer?**
- (Response) **30.0,0**  
 The elapsed test time is 30.0 s, and the type of timer is test time.
- Error** The execution of this command in a state other than the TEST state causes an execution error.

### Queries the contents of the set-value memory for withstand-voltage tests

<b>Syntax</b>	(Query)	<b>:MEMory:WITHstand:FILE? &lt;1 to 8 (NR1)&gt;</b> Queries the contents of the set-value memory for the withstand-voltage test number specified.
	(Response)	<b>&lt;Test frequency&gt;,&lt;Test voltage&gt;,&lt;Current upper-limit value&gt;,&lt;Current lower-limit value&gt;,&lt;Test time&gt;,&lt;Ramp-up time&gt;,&lt;Ramp-down time&gt;,&lt;initial voltage for ramp-up&gt;,&lt;contact check upper-limit voltage&gt;,&lt;contact check lower-limit voltage&gt;</b> Test frequency..... 0/1 (NR1) 0: AC50 Hz 1: AC60 Hz Test voltage ..... 0.20 to 5.00 (NR2, unit: kV) Current upper-limit value..... 0.1 to 20.0 (NR2, unit: mA) Current lower-limit value ..... 0.1 to 19.9 (NR2, unit: mA) 0: OFF Test time..... 0.3 to 999 (NR1/NR2, unit: s) 0: OFF Ramp-up time ..... 0.1 to 99.9 (NR2, unit: s) 0: OFF Ramp-down time ..... 0.1 to 99.9 (NR2, unit: s) 0: OFF initial voltage for ramp-up..... 0.0 to 1.0 (NR2, unit: kV) contact check upper-limit voltage. 0.20 to 5.00 (NR2, unit: kV) 0: OFF contact check lower-limit voltage . 0.20 to 5.00 (NR2, unit: kV) 0: OFF
<b>Example</b>	(Query)	<b>:MEMory:WITHstand:FILE? 1</b> Queries the contents of set-value memory file 1 for withstand-voltage tests.
	(Response)	<b>0,1.20,5.0,0,20.0,5.0,0,0.2,2.00,1.00</b> 50 Hz AC-withstand-voltage test; Test voltage: 1.2 kV; Upper-limit value: 5 mA; Lower-limit value: OFF; Test time: 20.0 s; Ramp-up time: 5.0 s; Ramp-down time: OFF; initial voltage for ramp-up 0.2 kV; contact check upper-limit voltage: 2 kV; contact check lower-limit voltage: 1 kV
<b>Error</b>		An execution error occurs when file numbers other than 1 to 8 are specified.

### Loads the set-value memory for withstand-voltage tests

<b>Syntax</b>	(Command)	<b>:MEMory:WITHstand:LOAD &lt;1 to 8 (NR1)&gt;</b> Loads the data saved for the withstand-voltage test file numbers specified.
<b>Example</b>		<b>:MEMory:WITHstand:LOAD 1</b> Loads memory file 1 for withstand-voltage tests.
<b>Error</b>		The execution of this command in a state other than the withstand-voltage mode READY state causes an execution error. The execution of this command in the insulation-resistance mode also causes an execution error. An execution error occurs when file numbers other than 1 to 8 are specified.

### Saves set values for withstand-voltage tests in memory

**Syntax** (Command) **:MEMory:WITHstand:SAVE <1 to 8 (NR1)>**  
Saves the withstand-voltage test settings in the memory file numbers specified.

**Example** **:MEMory:WITHstand:SAVE 2**  
Saves the settings for withstand-voltage tests in memory file 2.

**Error** The execution of this command in a state other than the withstand-voltage mode READY state causes an execution error.  
The execution of this command in the insulation-resistance mode also causes an execution error.  
An execution error occurs when file numbers other than 1 to 8 are specified.

### Clears the set-value memory for withstand-voltage tests

**Syntax** (Command) **:MEMory:WITHstand:CLEAr <1 to 8 (NR1)>**  
Clears and resets the data saved for the withstand-voltage test file numbers specified.

**Example** **:MEMory:WITHstand:CLEAr 3**  
Clears and resets the contents of memory file 3 for withstand-voltage tests.

**Error** The execution of this command in a state other than the READY state causes an execution error.  
An execution error occurs when file numbers other than 1 to 8 are specified.

### Queries the contents of the set-value for insulation-resistance tests

**Syntax** (Query) **:CONFigure:INSulation?**  
Queries the contents of the set-value for insulation-resistance tests.

(Response) **<Test-voltage>,<Resistance upper-limit value>,  
<Resistance lower-limit value>,<Test time>,<Delay time>,  
<contact check upper-limit voltage>,  
<contact check lower-limit voltage>**  
Test-voltage ..... 500, 1000 (NR1, unit: V)  
Resistance upper-limit value..... 0.2 to 2000 (NR1/NR2, unit: M $\Omega$ )  
Resistance lower-limit value ..... 0.2 to 2000 (NR1/NR2, unit: M $\Omega$ )  
Test time ..... 0.3 to 999 (NR1/NR2, unit: s)  
Delay time..... 0.1 to 99.9 (NR2, unit: s)  
contact check upper-limit voltage. 600, 1200 (NR1, unit: V)  
contact check lower-limit voltage . 500, 1200 (NR1, unit: V)

**Example** (Query) **:CONFigure:INSulation?**  
(Response) **500,2000,10.0,20.0,5.0,600,500**

The settings for insulation-resistance test are as follows.  
Test-voltage: 500 V, Resistance upper-limit value: 2000 M $\Omega$ , Resistance lower-limit value: 10.0 M $\Omega$ , Test time: 20.0 s, Delay time: 5.0 s, contact check upper-limit voltage: 600 V, contact check lower-limit voltage: 500 V

## Sets and Queries the test-voltage value for insulation-resistance tests

- Syntax**
- (Command) **:CONFigure:INSulation:VOLTage** <500,1000 (NRf)>  
Sets the test-voltage value (unit: V) for insulation-resistance tests, in the READY state.
- (Query) **:CONFigure:INSulation:VOLTage?**  
Queries the test-voltage value (unit: V) for insulation-resistance tests.
- (Response) <500,1000 (NR1)>
- Example**
- (Command) **:CONFigure:INSulation:VOLTage 500**  
Sets the test-voltage value for the insulation-resistance tests to 500 V.
- (Query) **:CONFigure:INSulation:VOLTage?**
- (Response) **500**  
The test-voltage value is 500 V.
- Error**
- The execution of this command in a state other than the READY state causes an execution error.
  - Execution error appears when value other than 500 or 1000 is sent.

## Sets and Queries the upper-limit test value for insulation-resistance tests

- Syntax**
- (Command) **:CONFigure:INSulation:RUPPer** <0.20 to 2000 (NRf)>  
Sets the upper-limit test value (unit: M $\Omega$ ) for insulation-resistance tests, in the READY state.
- (Query) **:CONFigure:INSulation:RUPPer?**  
Queries the upper-limit test value (unit: M $\Omega$ ) for insulation-resistance tests.
- (Response) <0.20 to 2000 (NR1/NR2)>
- Example**
- (Command) **:CONFigure:INSulation:RUPPer 2000**  
Sets the upper-limit test value for the insulation-resistance tests to 2000 M $\Omega$ .
- (Query) **:CONFigure:INSulation:RUPPer?**
- (Response) **2000**  
The upper-limit test value is 2000 M $\Omega$ .
- Error**
- The execution of this command in a state other than the READY state or "test setting state" causes an execution error.
  - When the upper limit of the insulation-resistance test is set to ON, an execution error will occur when "upper limit test value < lower limit test value" is set. In addition, when the upper limit of the insulation-resistance test is set to ON, and the auto range of the insulation resistance test is set to fixed range in the optional function setting, an execution error will occur when a value exceeding the resistance measurement range is set. When the test-voltage is 1000 V, values below 1.00 M $\Omega$  are outside the resistance measurement range. Refer to "4.1.2 Setting the Upper (Lower) Limit Value" (p. 51) for resistance measurement ranges.

### Sets and Queries the lower-limit test value for insulation-resistance tests

**Syntax** (Command) `:CONFigure:INSulation:RLOWer <0.20 to 2000 (NRf)>`  
Sets the lower-limit test value (unit: M $\Omega$ ) for insulation-resistance tests, in the READY state.

(Query) `:CONFigure:INSulation:RLOWer?`  
Queries the lower-limit test value (unit: M $\Omega$ ) for insulation-resistance tests.

(Response) `<0.20 to 2000 (NR1/NR2)>`

**Example** (Command) `:CONFigure:INSulation:RLOWer 10.0`  
Sets the lower-limit test value for the insulation-resistance tests to 10.0 M $\Omega$ .

(Query) `:CONFigure:INSulation:RLOWer?`

(Response) `10.0`  
The lower-limit test value is 10.0 M $\Omega$ .

- Error**
- The execution of this command in a state other than the READY state or "test setting state" causes an execution error.
  - When the upper limit of the insulation-resistance test is set to ON, an execution error will occur when "upper limit test value < lower limit test value" is set. An execution error will occur when a value exceeding the resistance measurement range is set. When the test-voltage is 1000 V, values below 1.00 M $\Omega$  are outside the resistance measurement range. Refer to "4.1.2 Setting the Upper (Lower) Limit Value" (p. 51) for resistance measurement ranges.

### Sets and Queries the test time for insulation-resistance tests

**Syntax** (Command) `:CONFigure:INSulation:TIMer <0.3 to 999 (NRf)>`  
Sets the test time (unit: s) for insulation-resistance tests, in the READY state.

(Query) `:CONFigure:INSulation:TIMer?`  
Queries the test time (unit: s) for insulation-resistance tests.

(Response) `<0.3 to 999 (NR1/NR2)>`

**Example** (Command) `:CONFigure:INSulation:TIMer 10.0`  
Sets the test time for the insulation-resistance tests to 10.0 s.

(Query) `:CONFigure:INSulation:TIMer?`

(Response) `10.0`  
The test time is set to 10.0 s.

- Error** The execution of this command in a state other than the READY state or "test setting state" causes an execution error.

### Sets and Queries the delay time for insulation-resistance tests

<b>Syntax</b>	(Command)	<b>:CONFigure:INSulation:DElay</b> <0.1 to 99.9 (NRf)> Sets the delay time (unit: s) for insulation-resistance tests in the READY state.
	(Query)	<b>:CONFigure:INSulation:DElay?</b> Queries the delay time (unit: s) for insulation-resistance tests.
	(Response)	<0.1 to 99.9 (NR2)>
<b>Example</b>	(Command)	<b>:CONFigure:INSulation:DElay 3.0</b> Sets the delay time for insulation-resistance tests at 3.0 s.
	(Query)	<b>:CONFigure:INSulation:DElay?</b>
	(Response)	<b>3.0</b> The delay time is set to 3.0 s.
<b>Error</b>	The execution of this command in a state other than the READY state or "test setting state" causes an execution error.	

### Enables/disables and Queries the upper-limit test value for insulation-resistance tests

<b>Syntax</b>	(Command)	<b>:INSulation:RUPPer</b> <ON/ OFF> Enables and disables the upper-limit test value for insulation-resistance tests, in the READY state.
	(Query)	<b>:INSulation:RUPPer?</b> Queries the upper-limit test value enablement for insulation-resistance tests.
	(Response)	<ON/ OFF>
<b>Example</b>	(Command)	<b>:INSulation:RUPPer ON</b> Enables the upper-limit test value for an insulation-resistance test.
	(Query)	<b>:INSulation:RUPPer?</b>
	(Response)	<b>OFF</b> The upper-limit test value is set to OFF.
<b>Error</b>	<ul style="list-style-type: none"> <li>• The execution of this command in a state other than the READY state or "test setting state" causes an execution error.</li> <li>• When the upper limit and lower limit values of the insulation-resistance test are set as "upper limit test value &lt; lower limit test value", an execution error will occur when the upper limit of the insulation-resistance test is set to ON. In addition, when the auto range of the insulation-resistance test is set to fixed range in the optional function setting, an execution error will occur when the upper limit test value exceeds the resistance measurement range when the upper test limit is set to ON. When the test-voltage is 1000 V, values below 1.00 MΩ are outside the resistance measurement range. Refer to "4.1.2 Setting the Upper (Lower) Limit Value" (p. 51) for resistance measurement ranges.</li> </ul>	



### Enables/disables and Queries the test time for insulation-resistance tests

- Syntax** (Command) **:INSulation:TIMer <ON/ OFF>**  
 Enables and disables the test time for insulation-resistance tests, in the READY state.
- (Query) **:INSulation:TIMer?**  
 Queries the test time enablement for insulation-resistance tests.
- (Response) **<ON/ OFF>**
- Example** (Command) **:INSulation:TIMer ON**  
 Enables the test time for an insulation-resistance test.
- (Query) **:INSulation:TIMer?**
- (Response) **OFF**  
 The test time is set to OFF.
- Error** The execution of this command in a state other than the READY state or "test setting state" causes an execution error.

### Enables/disables and Queries the delay time for insulation-resistance tests

- Syntax** (Command) **:INSulation:DElay <ON/ OFF>**  
 Sets the delay time ON/OFF for insulation-resistance tests in the READY state.
- (Query) **:INSulation:DElay?**  
 Queries the delay time ON/OFF for insulation-resistance tests.
- (Response) **<ON/ OFF>**
- Example** (Command) **:INSulation:DElay ON**  
 Sets the delay time for insulation-resistance tests to ON.
- (Query) **:INSulation:DElay?**
- (Response) **OFF**  
 The delay time is set to OFF.
- Error** The execution of this command in a state other than the READY state or "test setting state" causes an execution error.

### Enables/disables and Queries the contact check upper-limit voltage for insulation-resistance tests

- Syntax** (Command) **:INSulation:CNHI <ON/OFF>**  
Sets the contact check upper-limit voltage ON/OFF for insulation-resistance tests in the READY state.
- (Query) **:INSulation:CNHI?**  
Queries the contact check upper-limit voltage ON/OFF for insulation-resistance tests.
- (Response) **<ON/OFF>**
- Example** (Command) **:INSulation:CNHI ON**  
Sets the contact check upper-limit voltage for the insulation-resistance tests to ON.
- (Query) **:INSulation:CNHI?**
- (Response) **ON**  
The contact check upper-limit voltage for the insulation-resistance tests is set to ON.
- Error** The execution of this command in a state other than the READY state or "test setting state" causes an execution error.
- Note** When the upper-limit voltage for Contact Check in the insulation-resistance test is set to ON, the upper-limit voltage automatically become the following values.  
Test voltage 500 V : 600 V  
Test voltage 1000 V : 1200 V

### Enables/disables and Queries the contact check lower-limit voltage for insulation-resistance tests

- Syntax** (Command) **:INSulation:CNLO <ON/OFF>**  
Sets the contact check lower-limit voltage ON/OFF for insulation-resistance tests in the READY state.
- (Query) **:INSulation:CNLO?**  
Queries the contact check lower-limit voltage ON/OFF for insulation-resistance tests.
- (Response) **<ON/OFF>**
- Example** (Command) **:INSulation:CNLO ON**  
Sets the contact check lower-limit voltage for the insulation-resistance tests to ON.
- (Query) **:INSulation:CNLO?**
- (Response) **ON**  
The contact check lower-limit voltage for the insulation-resistance tests is set to ON.
- Error** The execution of this command in a state other than the READY state or "test setting state" causes an execution error.
- Note** When the lower-limit voltage for Contact Check in the insulation-resistance test is set to ON, the lower-limit voltage automatically become the following values.  
Test voltage 500 V : 500 V  
Test voltage 1000 V : 1000 V

---



---

**Queries the insulation-resistance test result**

---

**Syntax** (Query) **:MEASure:RESult:INSulation?**  
 Queries the results of the preceding test. Returns the determination and valid values at termination of the preceding test. The test results are updated upon termination of a new test.

(Response) **<Insulation-resistance test measured voltage value>**,  
**<Measured resistance value>**,**<Test time elapsed>**,**<Determination>**,  
**<Types of timers>**  
 Insulation-resistance test measured voltage value  
 ..... (NR1, unit: V)  
 Measured resistance value.. (NR1/NR2, unit: MΩ)  
                                   9999: O.F.  
                                   0.0 : U.F.  
                                   0 : No value  
 Test time elapsed..... (NR2, unit: s)  
 Determination ..... PASS/ UFAIL/ LFAIL/ ULFAIL/ OFF  
                                   PASS : PASS  
                                   UFAIL : UPPER-FAIL  
                                   LFAIL : LOWER-FAIL  
                                   ULFAIL : UPPER-LOWER-FAIL  
                                   OFF : Others (no determination)  
 Types of timers ..... 0/ 1 (NR1)  
                                   0 : Test time  
                                   1 : Delay time

**Example** (Query) **:MEASure:RESult:INSulation?**  
 (Response) **500,100,10.0,PASS,0**  
 Measured voltage value: 500 V; Measured resistance value: 100 MΩ; Test time elapsed: 10.0 s; Determination: PASS; Types of timers: Test time

**Note** Contact error type will not return.

---



---

**Queries the measured voltage value for insulation-resistance tests**

---

**Syntax** (Query) **:MEASure:INSulation:VOLTage?**  
 Queries the measured voltage value (unit: V) for insulation-resistance tests.

(Response) **<Measured voltage value for insulation-resistance tests (NR1)>**

**Example** (Query) **:MEASure:INSulation:VOLTage?**  
 (Response) **500**  
 The measured voltage value is 500 V.

**Error** The execution of this command in a state other than the TEST state causes an execution error.

---



---

**Queries the measured resistance value for insulation-resistance tests**

---

<b>Syntax</b>	(Query)	<b>:MEASure:INSulation:RESistance?</b> Queries the measured resistance value (unit: MΩ) for insulation-resistance tests.
	(Response)	<b>&lt;Insulation-resistance test measured resistance value (NR1/NR2)&gt;</b> 9999 .....O.F. 0.0 .....U.F. 0 .....No value
	(Query)	<b>:MEASure:INSulation:RESistance?</b>
	(Response)	<b>100.0</b> The measured resistance value is 100 MΩ.
<b>Error</b>		The execution of this command in a state other than the TEST state causes an execution error.

---



---

**Queries the test time elapsed for insulation-resistance tests**

---

<b>Syntax</b>	(Query)	<b>:MEASure:INSulation:TIMer?</b> Queries the test time elapsed (unit: s) for insulation-resistance tests.
	(Response)	<b>&lt;Insulation-resistance test time elapsed &gt;,&lt;Types of timers&gt;</b> Insulation-resistance test time elapsed (NR2, unit: s) Types of timers.....0/ 1 (NR1) 0 : Test time 1 : Delay time
<b>Example</b>	(Query)	<b>:MEASure:INSulation:TIMer?</b>
	(Response)	<b>10.0,0</b> Test time elapsed: 10.0 s Types of timers : Test time
<b>Error</b>		The execution of this command in a state other than the TEST state causes an execution error.

---

Queries the contents of the set-value memory for insulation-resistance tests

**Syntax** (Query) **:MEMory:INSulation:FILE? <1 to 8 (NR1)>**  
 Queries the contents of the set-value memory for the insulation-resistance test number specified.

(Response) **<Test-voltage value>,<Upper-limit value>,<Lower-limit value>,<Test time setting value>,<Delay time setting value>,<contact check upper-limit voltage>,<contact check lower-limit voltage>**  
 Test-voltage value..... 500, 1000 (NR1, unit: V)  
 Upper-limit value..... 0, 0.20 to 2000 (NR1/NR2, unit: M $\Omega$ )  
 0: OFF  
 Lower-limit value..... 0.20 to 2000 (NR1/NR2, unit: M $\Omega$ )  
 Test time setting value ..... 0, 0.3 to 999 (NR1/NR2, unit: s)  
 0: OFF  
 Delay time setting value..... 0, 0.1 to 99.9 (NR2, unit: s)  
 0: OFF  
 contact check upper-limit voltage. 600, 1200 (NR1, unit: V)  
 0: OFF  
 contact check lower-limit voltage . 500, 1000 (NR1, unit: V)  
 0: OFF

**Example** (Query) **:MEMory:INSulation:FILE? 1**  
 Queries the contents of set-value memory file 1 for insulation-resistance tests.

(Response) **3,1000,0,100,5.0,1.0,1200,1000**  
 Insulation-resistance test; Test voltage: 1000 V;  
 Upper-limit value: OFF; Lower-limit value: 100 M $\Omega$ ; Test time: 5.0 s;  
 Delay time: 1.0 s; contact check upper-limit voltage: 1200 V; contact check lower-limit voltage: 1000 V

**Error**

- An execution error occurs when file numbers other than 1 to 8 are specified.
- Execution error appears when a mistake occurs in the combination of the test voltage and upper-limit voltage for Contact Check.  
 Test voltage: 500 V → contact check upper-limit voltage: 600 V, contact check lower-limit voltage: 500 V  
 Test voltage: 1000V → contact check upper-limit voltage: 1200 V, contact check lower-limit voltage: 1000 V



---

---

**Loads the set-value memory for insulation-resistance tests**

---

---

**Syntax** (Command) **:MEMory:INSulation:LOAD <1 to 8 (NR1)>**  
Loads the data saved for the insulation-resistance test file numbers specified.

**Example** **:MEMory:INSulation:LOAD 1**  
Loads memory file 1 for insulation-resistance tests.

- Error**
- The execution of this command in a state other than the insulation-resistance mode READY state causes an execution error.
  - The execution of this command in the withstand-voltage mode also causes an execution error.
  - An execution error occurs when file numbers other than 1 to 8 are specified.

---

---

**Saves set values for insulation-resistance tests in memory**

---

---

**Syntax** (Command) **:MEMory:INSulation:SAVE <1 to 8 (NR1)>**  
Saves the insulation-resistance test settings in the memory file numbers specified.

**Example** **:MEMory:INSulation:SAVE 2**  
Saves the settings for insulation-resistance tests in memory file 2.

- Error**
- The execution of this command in a state other than the insulation-resistance mode READY state causes an execution error.
  - The execution of this command in the withstand-voltage mode also causes an execution error.
  - An execution error occurs when file numbers other than 1 to 8 are specified.

---

---

**Clears the set-value memory for insulation-resistance tests**

---

---

**Syntax** (Command) **:MEMory:INSulation:CLEar <1 to 8 (NR1)>**  
Clears and resets the data saved for the insulation-resistance test file numbers specified.

**Example** **:MEMory:INSulation:CLEar 3**  
Clears and resets the contents of memory file 3 for insulation-resistance tests.

- Error**
- The execution of this command in a state other than the READY state causes an execution error.
  - An execution error occurs when file numbers other than 1 to 8 are specified.
-

## Sets the optional functions 1

**Syntax** (Command) : **SYSTem:OPTion:P1** <Pass hold function>, <Fail hold function>, <STOP Hold function>, <Momentary output function>, <Double action function>, <Fail mode function>, <Interface command "START" function>, <Inter-lock function>, <Output-voltage restricting value>  
Sets the contents on Page 1 of the Optional Function Setting Screen.

(Data) <Pass hold function>, <Fail hold function>, <STOP Hold function>, <Momentary output function>, <Double action function>, <Fail mode function>, <Interface command "START" function>, <Inter-lock function>, <Output-voltage restricting value>

Pass hold function ..... 0/1 (NR1)  
0: Not held  
1: Held

Fail hold function..... 0/1 (NR1)  
0: Not held  
1: Held

STOP Hold function ..... 0/1 (NR1)  
0: Not held  
1: Held

Momentary output function .. 0/1 (NR1)  
0: Not set  
1: Set

Double action function ..... 0/1 (NR1)  
0: Not set  
1: Set

Fail mode function ..... 0/1 (NR1)  
0: Not set  
1: Set

Interface command "START" function  
..... 0/1/2/3 (NR1)  
0: Start command invalid, changing the voltage supplied using keys not possible  
1: Start command valid, changing the voltage supplied using keys not possible  
2: Start command invalid, changing the voltage supplied using keys possible  
3: Start command valid, changing the voltage supplied using keys possible

Inter-lock function ..... 0/1 (NR1)  
0: Not set  
1: Set

Withstand-voltage test  
Output-voltage restricting value ..... 0.2 to 5.0 (NR2, unit: kV)

**Example** (Command) : **SYSTem:OPTion:P1 1,1,0,0,0,0,1,0,3.2**  
Set the contents on Page 1 of the Optional Function Setting as follows.  
Pass hold function: Held, Fail hold function: Held,  
STOP Hold function: Not held,  
Momentary output function: Not set, Double action function: Not set,  
Fail mode function: Not set, Interface command "START" function: Start command valid, changing the voltage supplied using keys not possible,  
Inter-lock function: Not set,  
Withstand-voltage test Output-voltage restricting value: 3.2 kV

- Error**
- The execution of this command in a state other than the READY state causes an execution error.
  - Execution error appears when value other than specified is set.

### Queries the optional functions 1

<b>Syntax</b>	(Query)	<b>:SYStem:OPTion:P1?</b> Query contents on Page 1 of the Optional Function Setting Screen.
	(Response)	<p>&lt;Pass hold function&gt;,&lt;Fail hold function&gt;,&lt;STOP Hold function&gt;, &lt;Momentary output function&gt;,&lt;Double action function&gt;, &lt;Fail mode function&gt;,&lt;Interface command "START" function&gt;, &lt;Inter-lock function&gt;,&lt;Output-voltage restricting value&gt;</p> <p>Pass hold function..... 0/1 (NR1) 0: Not held 1: Held</p> <p>Fail hold function..... 0/1 (NR1) 0: Not held 1: Held</p> <p>STOP Hold function ..... 0/1 (NR1) 0: Not held 1: Held</p> <p>Momentary output function... 0/1 (NR1) 0: Not set 1: Set</p> <p>Double action function ..... 0/1 (NR1) 0: Not set 1: Set</p> <p>Fail mode function..... 0/1 (NR1) 0: Not set 1: Set</p> <p>Interface command "START" function ..... 0/1/2/3 (NR1) 0: Start command invalid, changing the voltage supplied using keys not possible 1: Start command valid, changing the voltage supplied using keys not possible 2: Start command invalid, changing the voltage supplied using keys possible 3: Start command valid, changing the voltage supplied using keys possible</p> <p>Inter-lock function..... 0/1 (NR1) 0: Not set 1: Set</p> <p>Withstand-voltage test Output-voltage restricting value ..... 0.2 to 5.0 (NR2, unit: kV)</p>
<b>Example</b>	(Query)	<b>:SYStem:OPTion:P1?</b>
	(Response)	<b>1,1,0,0,0,0,1,0,3.2</b> The setting for Page 1 of the Optional Function Setting Screen is as follows. Pass hold function: Held, Fail hold function: Held, STOP Hold function: Not held, Momentary output function: Not set, Double action function: Not set, Fail mode function: Not set, Interface command "START" function: Start com- mand valid, changing the voltage supplied using keys not possible, Inter-lock function: Not set, Withstand-voltage test Output-voltage restricting value: 3.2 kV



## Sets the optional functions 2

<b>Syntax</b>	(Command) <b>:SYStem:OPTion:P2</b> <Insulation-resistance test measurement range>, <Insulation-resistance test termination mode>, <PC interface>,<START protection function>,<TEST-signal output>, <Forced termination's evaluation output>, <Continuous Test mode>,<GP-IB address> Sets the contents on Page 2 of the Optional Function Setting Screen.
(Data)	Insulation-resistance test measurement range...0/1 (NR1) 0: Fixed range 1: Auto range Insulation-resistance test termination mode .....0/1/2 (NR1) 0: Test for set time 1: Terminate test at PASS 2: Terminate test at FAIL PC interface .....0/1/2 (NR1) 0: RS-232C (9600bps) 1: RS-232C (19200bps) 2: GP-IB START protection function... 0/1 (NR1) 0: Not set 1: Set TEST-signal output .....0/1/2 (NR1) 0: TEST signal ON, while all test time including ramp-up and ramp-down time 1: TEST signal ON, while set test time 2: TEST signal ON, only while ramp-up and ramp-down time Forced termination's evaluation output .....0/1 (NR1) 0: No evaluation 1: Evaluation Continuous Test mode ....0/1 (NR1) 0: Test stops when <b>FAIL</b> appears. 1: Test continues when <b>FAIL</b> appears GP-IB address .....1 to 30 (NR1)

**Example** (Command) **:SYStem:OPTion:P2 0,2,2,1,1,0,0,15**  
Set the contents on Page 2 of the Optional Function Setting as follows.  
Insulation-resistance test measurement range: Fixed range,  
Insulation-resistance test termination mode: Terminate test at FAIL,  
PC interface: GP-IB,  
START protection function: Set,  
TEST-signal output: TEST signal ON, while set test time,  
Forced termination's evaluation output: No evaluation,  
Continuous Test mode: Test stops when FAIL appears,  
GP-IB address: 15

- Error**
- The execution of this command in a state other than the READY state causes an execution error.
  - Execution error appears when value other than specified is set.

### Queries the optional functions 2

<b>Syntax</b>	(Query)	<b>:SYStem:OPTion:P2?</b> Query contents on Page 2 of the Optional Function Setting Screen.
	(Response)	<p>&lt;Insulation-resistance test measurement range&gt;,          &lt;Insulation-resistance test termination mode&gt;,          &lt;PC interface&gt;,&lt;START protection function&gt;,&lt;TEST-signal output&gt;,          &lt;Forced termination's evaluation output&gt;,          &lt;Continuous Test mode&gt;,&lt;GP-IB address&gt;</p> <p>Insulation-resistance test measurement range .. 0/1 (NR1)              0: Fixed range              1: Auto range</p> <p>Insulation-resistance test termination mode..... 0/1/2 (NR1)              0: Test for set time              1: Terminate test at PASS              2: Terminate test at FAIL</p> <p>PC interface .....0/1/2 (NR1)              0: RS-232C (9600bps)              1: RS-232C (19200bps)              2: GP-IB</p> <p>START protection function ... 0/1 (NR1)              0: Not set              1: Set</p> <p>TEST-signal output .....0/1/2 (NR1)              0: TEST signal ON, while all test time including                  ramp-up and ramp-down time              1: TEST signal ON, while set test time              2: TEST signal ON, only while ramp-up and                  ramp-down time</p> <p>Forced termination's          evaluation output.....0/1 (NR1)              0: No evaluation              1: Evaluation</p> <p>Continuous Test mode ....0/1 (NR1)              0: Test stops when <b>FAIL</b> appears.              1: Test continues when <b>FAIL</b> appears</p> <p>GP-IB address ..... 1 to 30 (NR1)</p>
<b>Example</b>	(Query)	<b>:SYStem:OPTion:P2?</b>
	(Response)	<b>0,2,2,1,1,0,0,15</b> Insulation-resistance test measurement range: Fixed range, Insulation-resistance test termination mode: Terminate test at FAIL, PC interface: GP-IB, START protection function: Set, TEST-signal output: TEST signal ON, while set test time, Forced termination's evaluation output: No evaluation, Continuous Test mode: Test stops when FAIL appears, GP-IB address: 15

## Sets and Queries status out

- Syntax** (Command) **:SYSTem:STATus** <H.V.ON>,<TEST>,<PASS>,<FAIL>,<INT.LOCK>,<READY>,<EXT.CONT.>,<POWER.ON>  
Sets the contents for status out.
- (Query) **:SYSTem:STATus?**  
Queries the contents for status out.
- (Response) <H.V.ON>,<TEST>,<PASS>,<FAIL>,<INT.LOCK>,<READY>,<EXT.C  
ONT.>,<POWER.ON>  
Contents for status out..... 0/1 (NR1)  
0: Not set  
1: Set
- Example** (Command) **:SYSTem:STATus 1,1,0,0,0,0,0,0**  
Set the contents for status out as follows.  
H.V.ON: Set, TEST: Set,  
PASS: Not set, FAIL: Not set,  
INT.LOCK: Not set, READY: Not set,  
EXT.CONT.0: Not set, POWER.ON: Not set
- (Query) **:SYSTem:STATus?**
- (Response) **1,1,0,0,0,0,0,0**  
The contents for status out are as follows.  
H.V.ON: Set, TEST: Set,  
PASS: Not set, FAIL: Not set,  
INT.LOCK: Not set, READY: Not set,  
EXT.CONT.0: Not set, POWER.ON: Not set

## Sets and Queries the data terminator for response messages



<b>Syntax</b>	(Command)	<b>:TRANsmit:TERMinator &lt;0 to 1 (NR1)&gt;</b> Sets the data terminator for response messages. When powering on, the data is initially set to 0 (LF+EOI).
	(Query)	<b>:TRANsmit:TERMinator?</b> Returns the data terminator for response messages as a numerical value (0 or 1) in NR1 format.
	(Response)	<b>&lt;0 to 1 (NR1)&gt;</b> 0 ..... LF+EOI 1 ..... CR, LF+EOI
<b>Example</b>	(Command)	<b>:TRANsmit:TERMinator 0</b> Sets the terminator for the response message to LF + EOI.
	(Query)	<b>:TRANsmit:TERMinator?</b>
	(Response)	<b>0</b> Data terminator has been set to LF+EOI.

## Cancel remote

<b>Syntax</b>	(Command)	<b>:SYSTem:LOCAL</b> The remote state is canceled, and the system goes into the local state.
	<b>Error</b>	The execution of this command in a state other than the remote state causes an execution error.

## Initialize to the default factory settings

<b>Syntax</b>	(Command)	<b>:SYSTem:RESet</b> This resets the settings to the default factory settings. After initialization, the screen returns to the initial screen.
	<b>Note</b>	<ul style="list-style-type: none"> <li>• Send the <b>*RST</b> command if initialization of saved data is not required.</li> <li>• For items to be initialized, refer to "11.4 System Reset" (p. 201)</li> </ul>

### 9.4.3 Transmission and response formats

All the response format display items other than the elapsed time are identical to the VFD format (without a space).

Test-voltage value, Measured voltage value (withstand-voltage mode, unit: kV)

□. □□

Three digits (in NR2 format)

Test-voltage value (insulation-resistance mode, unit: V)

□□□□

□□□

Three or four digits (in NR1 format)

Measured voltage value (insulation-resistance mode, unit: V)

□□□□

□□□

□□

□

One, two, three or four digits (in NR1 format)

Upper-limit test value, Lower-limit test value (withstand-voltage mode, unit: mA)

□□. □

□. □

Two or three digits (in NR2 format)

Upper-limit test value, Lower-limit test value (insulation-resistance mode, unit: MΩ)

□□□□

□□□

□□□. □

□□. □

□□. □□

□. □□

Three or four digits (in NR1 or NR2 format)

Measured current value (withstand-voltage mode, unit: mA)

□□. □

□□. □□

□. □

□. □□

Two, three or four digits (in NR2 format)

Measured resistance value (insulation-resistance mode, unit: MΩ)

□□□□

□□□

□□□. □

□□. □

□□. □□

□. □□

Three or four digits (in NR1 or NR2 format)

Test time setting value (withstand-voltage mode and insulation-resistance mode, unit: s)

Ramp timer time setting value (withstand-voltage mode, unit: s)

Delay time setting value (insulation-resistance mode, unit: s)

□□□

□□. □

□. □

Two or three digits (in NR1 or NR2 format)

Each time elapsed (withstand-voltage mode and insulation-resistance mode, unit: s)

□□□. □

□□. □

□. □

Two, three or four digits (in NR2 format)

### 9.4.4 Sample program Flowchart

#### Basic settings and measurements of withstand-voltage test

Set the test settings of 3174 as follows.

- Test-voltage : 1.00 kV
  - Lower-limit test value : OFF
  - Upper-limit test value : 1.0 mA
  - Test time : 60.0 s
  - Ramp-up time : 5.0 s
  - Ramp-down time : OFF
  - Type of voltage : 60 Hz AC
  - Initial voltage for ramp-up: 0.5
  - Upper-limit voltage for contact check: 1.10 kV
  - Lower-limit voltage for contact check: 0.90 kV
- Execute the test once, and show the data on the display.

Pre-set the contents of the Optional Function Setting as follows.

- Double Action: 0 (OFF)
- Interface Command "START": 1 (Start command valid, changing the voltage supplied using keys not possible)
- PC interface: Set the PC interface to be used. When GP-IB is used, set the GP-IB address.

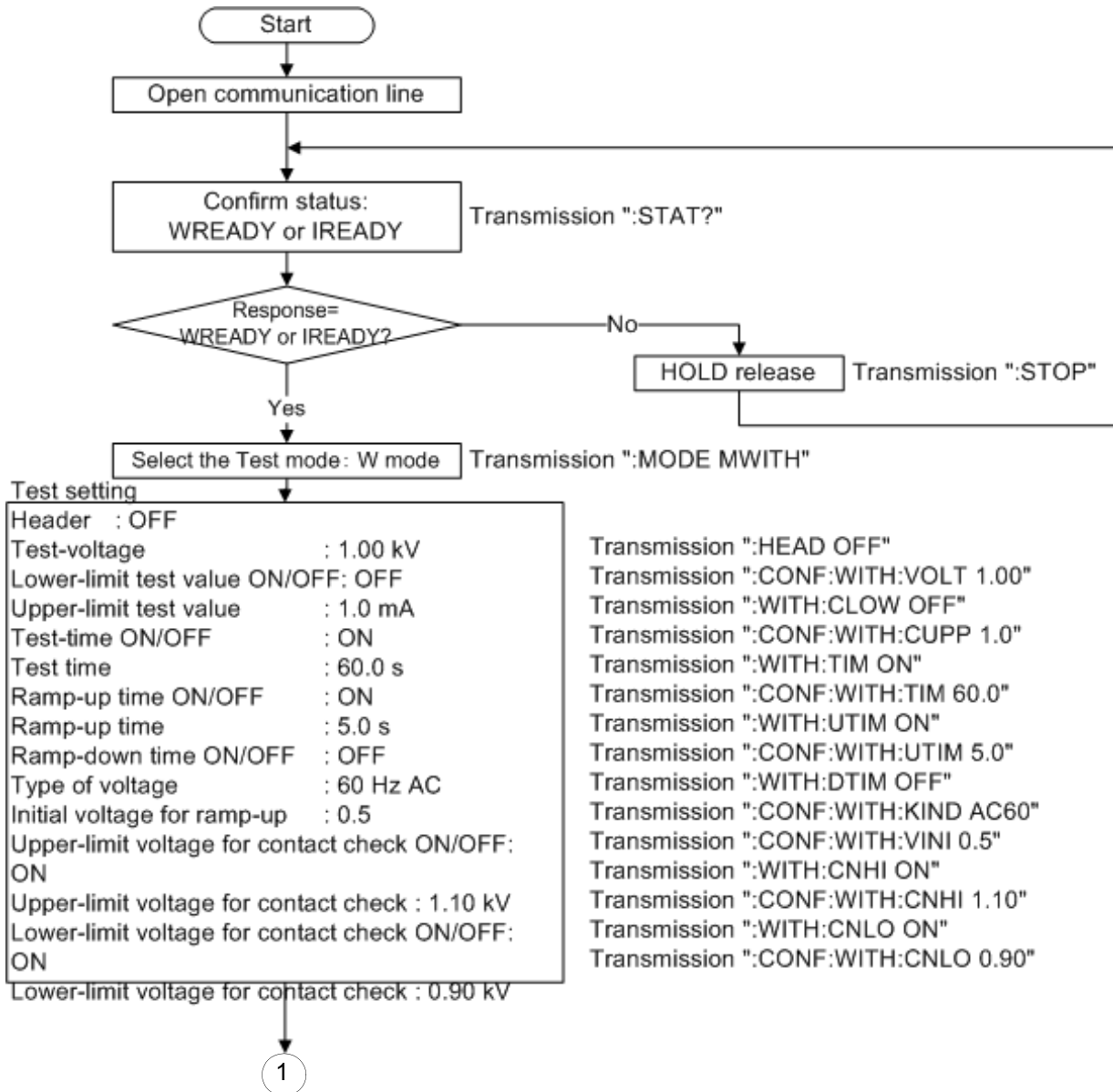

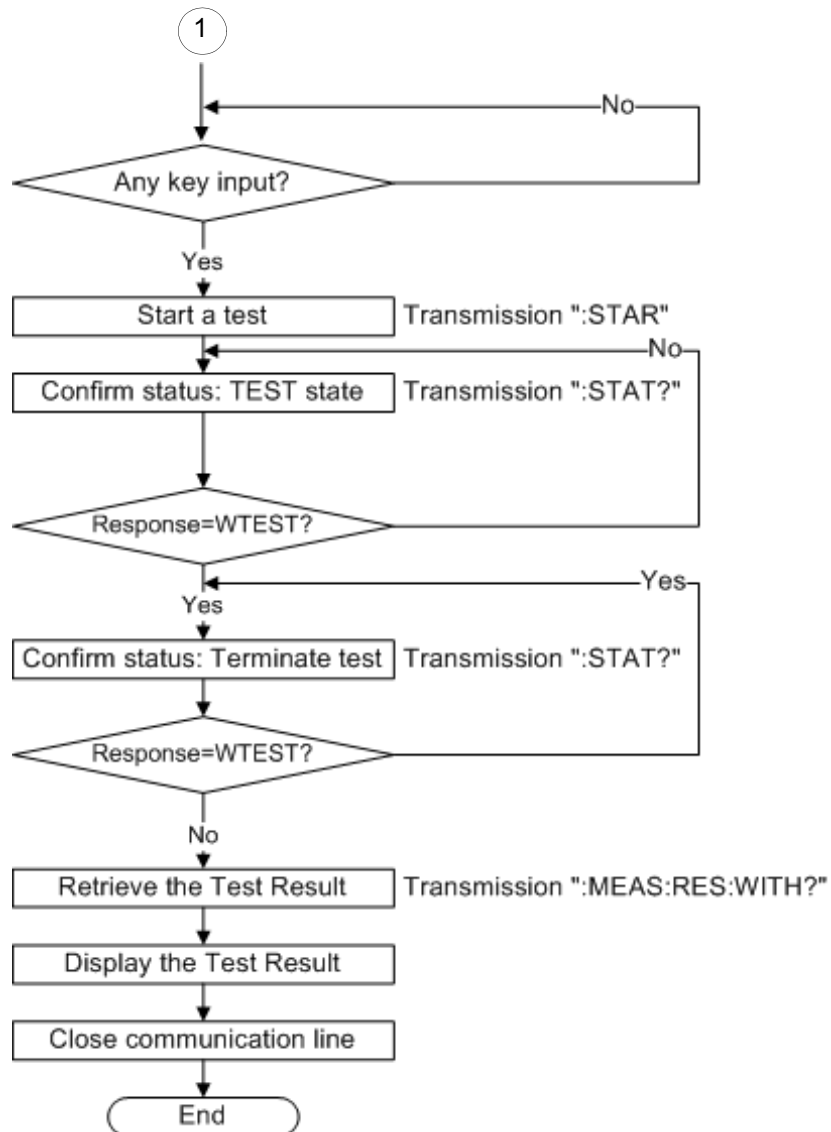

### Basic settings and measurements of insulation-resistance test

Set the test settings of 3174 as follows.

- Test-voltage : 500 V
- Lower-limit test value: 1.00 MΩ (Upper-limit value: 10.00 MΩ)  
\* When the figure in the bracket show the upper-limit value is also set.
- Test time : 10.0 s
- Delay time : 1.0 s
- Upper-limit voltage for contact check: ON
- Lower-limit voltage for contact check: ON

Execute the test once, and show the data on the display.

Pre-set the contents of the Optional Function Setting as follows.

- Double Action: 0 (OFF)
- Interface Command "START": 1 (Start command valid, changing the voltage supplied using keys not possible)
- PC interface: Set the PC interface to be used. When GP-IB is used, set the GP-IB address.

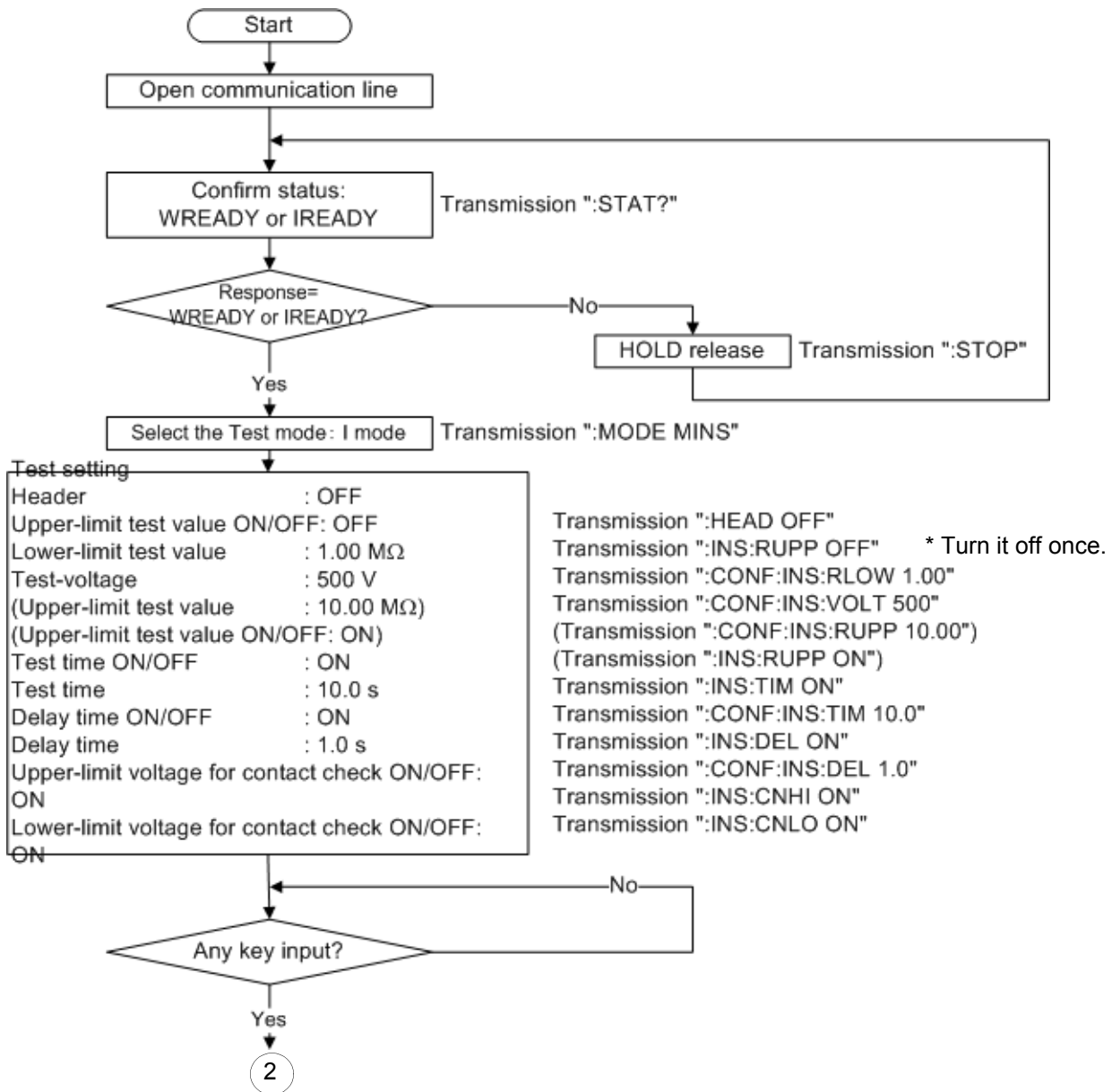



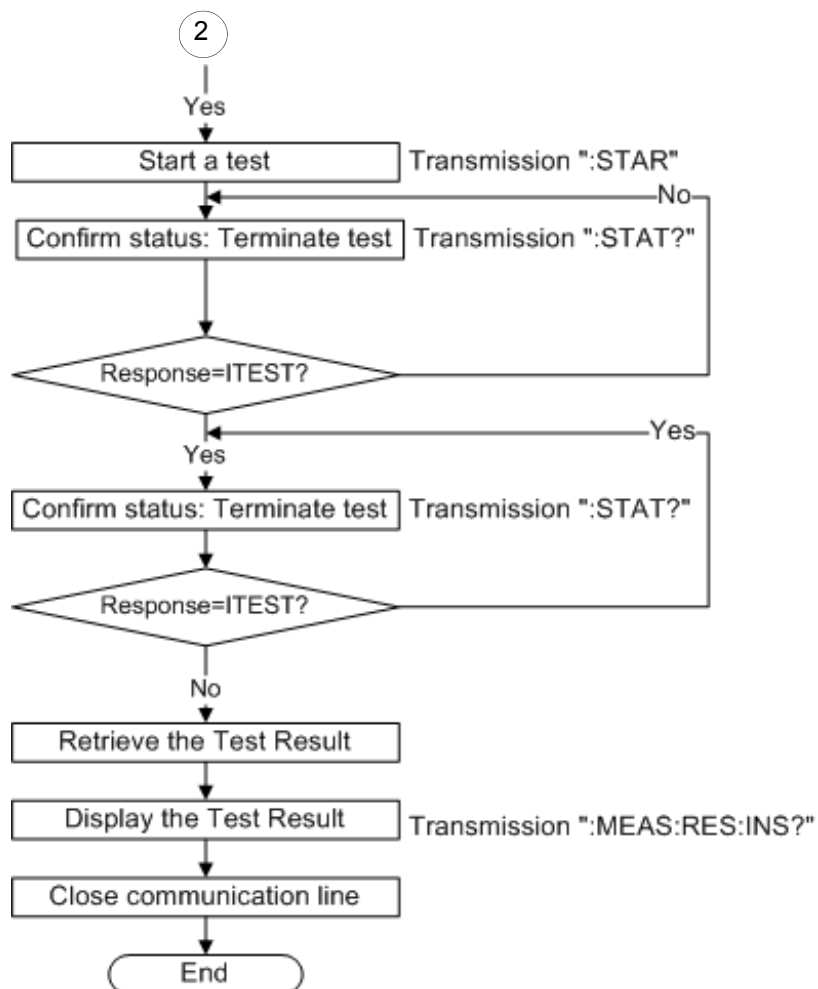

## 9.5 Interface Command "START"

See "Appendix2 List of Optional Functions" (p. A4)

When RS-232C or GP-IB is used for control, settings can be made to specify whether to accept the test start command ":START". In addition, when this setting is not set, output voltage during voltage supply cannot be changed.

1. (**READY** is lit)

Make sure the **READY** lamp is lit on the screen.

2.

SHIFT

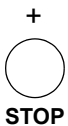

\* **READY** will not be displayed during the Double Action setting.

Press the **STOP** key while holding down the **SHIFT** key to display the optional screen (page 1).



3.



Press the **▶** key to move the flashing cursor to the interface command.

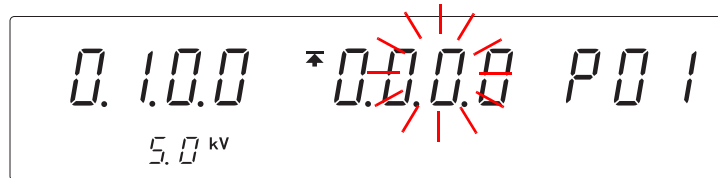

4.



or



Press the **▲** / **▼** keys to select.

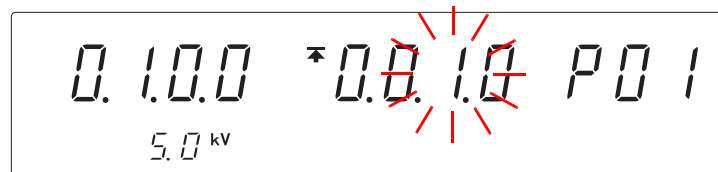

<Ex.> Select "Start command valid, changing the voltage supplied using keys not possible"

Interface Command "START"

- 0: Start command invalid (Initial setting)  
changing the voltage supplied using keys not possible
- 1: Start command valid  
changing the voltage supplied using keys not possible
- 2: Start command invalid  
changing the voltage supplied using keys possible
- 3: Start command valid  
changing the voltage supplied using keys possible

When the START command is valid, the output voltage can be changed during voltage supply using the command key.

See "6.6 Changing the Output Voltage during the withstanding test" (p. 91)

Press **SHIFT** + **STOP** keys to complete the setting value.  
The instrument reverts to the READY state.

5.

SHIFT

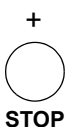

To continue to the setting for the next item, press the **▶** key.

**NOTE**

When the interface command "START" is valid, the command to change the voltage during voltage supply is also valid.

# Specifications Chapter 10

## 10.1 Basic Specifications

### Accuracy

f.s. (maximum display value or scale length)

The maximum displayable value or scale length. This is usually the name of the currently selected range.

rdg. (reading or displayed value)

The value currently being measured and indicated on the measuring instrument.

### AC Withstand-voltage test portion

AC Voltage Output Component	
Output voltage	0.2 to 5 kV AC (50 Hz/60 Hz), Single range output Measurement category I , Anticipated transient overvoltage 1500 V
Output frequency	50 Hz/60 Hz, $\pm 0.2\%$
Voltage output method	PWM switching (0 V start, Voltage change during supply possible)
Voltage setting method	Digital setting, Setting resolution: 0.01 kV
Output voltage accuracy	$\pm 1.5\%$ of the setting value $\pm 20$ V
Maximum rated power	100 VA AC (5 kV/20 mA), continuous
Transformer capacity	100 VA
Output waveform	Sine wave
Fluctuation rate	15% or less (At Maximum rated load $\rightarrow$ no load converge to set value within 1 second)
Distortion rate	5% or less (At 40 M $\Omega$ , load 5 kV output: impedance of measuring device during measurement)
Voltage measurement	True RMS indication Digital meter, 0 to 1.00 kVrms AC Withstand-voltage, Accuracy $\pm 15$ V 1 to 5.00 kVrms AC Withstand-voltage, Accuracy $\pm 1.5\%$ rdg
Current Detection	
Current measurement range	0.01 mA to 20 mA (2-range structure)
Designated value	True RMS indication
Measurement range	10 mA/20 mA
Measured area and resolution	0.00 mA to 9.99 mA, 0.01 mA (10-mA range) 0.0 mA to 20.0 mA, 0.1 mA (20-mA range)
Measurement accuracy	$\pm 2\%$ rdg $\pm 0.05$ mA (10 mA range) $\pm 2\%$ rdg $\pm 0.5$ mA (20 mA range)

Decision Function	Window comparator method (digital setting) for setting upper-limit and lower-limit values
Decision method	
Decision contents	UPPER FAIL : when measured current exceeds the upper-limit setting PASS : when measured current remains between the upper- / lower limit settings for set time LOWER FAIL : when the measured current is below the lower-limit setting UPPER LOWER FAIL : Test errors such as when there is no pre-set voltage out-put
Decision process	Output to the display, beeper sound, signals to EXT I/O for each decision result
Setting range	AC: 0.1 to 20.0 mA (Upper-limit value), 0.1 to 19.9 mA (Lower-limit value), Setting resolution: 0.1 mA

### Insulation resistance test portion

Rated supply	500 V/1000 V DC (positive electrode)
No load voltage	1 to 1.2 times of rated voltage
Voltage measurement	Digital meter, 0 to 1000 V DC Insulation resistance, Accuracy $\pm 30$ V
Rated measurement current	1 to 1.2 mA
Short-circuit current	4 to 5 mA (500 V), 2 to 3 mA (1000 V)
Measurement range	0.5 M to 2000 M $\Omega$ (500 V), 1.0 M to 2000 M $\Omega$ (1000 V)
Accuracy guarantee	0.5 M to 999 M $\Omega$ (500 V), 1 M $\Omega$ to 999 M $\Omega$ (1000 V): $\pm 4\%$ rdg 1000 M $\Omega$ to 2000 M $\Omega$ : $\pm 8\%$ rdg
Measured resolution	0.01 M $\Omega$ (0.20 M $\Omega$ to 19.99 M $\Omega$ ) 0.1 M $\Omega$ (20.0 M $\Omega$ to 199.9 M $\Omega$ ) 1 M $\Omega$ (200 M $\Omega$ to 2000 M $\Omega$ )
Measurement resistance range	2 M $\Omega$ , 20 M $\Omega$ , 200 M $\Omega$ , 2000 M $\Omega$ (500 V) 4 M $\Omega$ , 40 M $\Omega$ , 400 M $\Omega$ , 2000 M $\Omega$ (1000 V)

#### Decision Function

Decision method	Window comparator method (digital setting)
Decision contents	UPPER FAIL : When measured resistance exceeds the upper-limit setting. PASS : When measured resistance is within the upper-limit and lower- limit settings. LOWER FAIL : When the measured resistance is below the lower-limit setting. UPPER LOWER FAIL : Test errors such as when voltage is low
Decision process	Output to the display, beeper sound, signals to EXT I/O for each decision result
Setting resolution	0.01 M $\Omega$ (0.2 to 2.00 M $\Omega$ ) 0.1 M $\Omega$ (2.10 to 20.0 M $\Omega$ ) 1 M $\Omega$ (21.0 to 200 M $\Omega$ ) 10 M $\Omega$ (210 to 2000 M $\Omega$ )

## Timer Section

Setting range	0.3 to 999 s
Operation	At ON Setting : Displays the time that is counted down from the start At OFF Setting : Displays the time that has elapsed from the start
Setting resolution	0.1 s: 0.3 to 99.9 s, 1 s: 100 to 999 s
Accuracy	0.3 to 99.9 s: $\pm 50$ ms, 100 to 999 s: $\pm 0.5$ s
<b>Ramp timer</b>	
Setting range	0.1 to 99.9 s, The ramp-up time and ramp-down time can be set individually.
Operation	Ramp-up : Using ramp-up time from initial voltage to test voltage to increase the output voltage gradually Ramp-down : Using ramp-down time after test time timer to decrease the output voltage from pre-set voltage to 0 V Both are displayed as time counted down from the set time.
Setting resolution	0.1 s
Accuracy	$\pm 50$ ms
Delay timer	(Withstand-voltage test)
Setting range	0.1 to 99.9 s
Setting resolution	0.1 s
Accuracy	$\pm 50$ ms

## Interface

### EXT I/O (Rear panel: Each signal is insulated internally with a photocoupler) 36pin Amphenol connector

Power supply	Internal power supply Between ISO_DCV-ISO_COM: 15 V $\pm$ 0.5 V, 100 mA (total)
Signal level	All signals Active LOW
Output signals	Open collector output, (insulated with a photocoupler), All signals Active LOW
Maximum load voltage	30 V DC
Maximum output current	100 mA DC/ For 1 signal
Output saturation voltage	1.5 V DC or less
Signal names	H.V.ON : Generating voltage for output TEST : Test in progress PASS : PASS status at Evaluation Function setting UFAIL : UPPER-FAIL status at Evaluation Function setting LFAIL : LOWER-FAIL status at Evaluation Function setting READY : Standby I_MODE : Insulation-resistance test mode W_MODE : Withstand-voltage test mode W_FAIL : Withstand-voltage test failed I_FAIL : Insulation-resistance test failed MODE1 : Indicates current mode with MODE2 (W, I, W-I, I-W) MODE2 : Indicates current mode with MODE1 ISO.DCV : Internal standby insulated power supply 15 V, 0.1 A ISO.COM : Internal standby insulated power supply connections

Input signals	All Active LOW inputs (insulated with a photocoupler)
Maximum input voltage	30 V DC
HIGH level voltage	Above 15 V below 30 V DC or open
LOW level voltage	5 V DC or less (-6 mA typ.)
Signal names	START : Test start STOP : Test stop EXT-E : External I/O effective INT.LOCK : Interlock MEM0 : Memory Selection 0 MEM1 : Memory Selection 1 MEM2 : Memory Selection 2 MEM3 : Memory Selection 3 MEM_E : Memory Enable Note: Load starts when memory number is selected from MEM0 to 3 and MEM_E is set to L.

**Remote Control Box (External Switch Terminal)**

Input signal (contact input)	START, STOP, SW.EN (External Switch Terminal valid)
Output signal	LED light signal (40 mA max. load current)
Priority placings for Key input	RS-232C > Remote control box > EXT I/O > Front panel of the 3174 (3174-01) (When START setting is valid with RS-232C) (Only START, STOP, Interlock are valid and all have the same level of priority regardless of the condition of EXT_E))

**RS-232C**

Synchronization method	Start-stop synchronization, full duplex
Transfer rate	9600 bps/ 19200 bps
Data length	8 bits
Parity	None
Stop bit	1bit
Hand shake	No X flow, hardware flow control
Delimiter	Receiving : CR, CR+LF Transmitting : CR+LF

**GP-IB (-01 model)**

Command structure	Reference standard: IEEE 488.2-1987 (3174-01)
-------------------	---

## Other Functions

Memory function	This function allows test conditions to be saved.	
Memory contents	<p>Withstand-voltage test mode test-voltage type (AC 50 Hz/60 Hz), test-voltage, upper (lower)-limit current evaluation values, test-time, ramp-up (down) time, initial voltage for ramp-up, upper (lower)-limit for Contact Check voltage (Both upper-limit and lower-limit values can be set)</p> <p>Insulation-resistance test mode test-voltage, upper (lower)-limit resistance evaluation values, test-time, delay time, upper (lower)-limit for Contact Check voltage</p>	
Memory space	8 sets each for withstand and insulation (save, load possible)	
Pass hold function	Enable this function to hold the Pass state when detected, to facilitate confirmation.	
Fail hold function	Enable this function to hold the Fail state when detected, to facilitate confirmation.	
Hold function	Maintains the measurement value obtained at the end of a test	
Buzzer settings	Buzzer volume settings for test screening and errors (buzzer volume settings are to be performed for PASS and FAIL separately)	
Momentary output	This function allows voltage output only when the <b>START</b> key is pressed.	
Double action	Enable this function to allow testing to start only when the <b>START</b> key is pressed within about 0.5 seconds after the <b>STOP</b> key.	
Fail mode	Enable this function to restrict hold release to the <b>STOP</b> key on the main unit.	
PC command "START"	This function validates or invalidates START from RS-232C or GP-IB.	
Interlock function	ON/OFF setting for interlock function restricting test start conditions	
Maximum output voltage settings	To set the upper-limit for the output voltage (common to withstand-voltage mode and insulation-resistance mode)	
Insulation-resistance range	Sets fixed range/ auto range	
Insulation-resistance test termination mode	Enable this mode to terminate an insulation-resistance test when the set time of the timer has elapsed (unrelated to screening), or to terminate the test at PASS or FAIL screening.	
PC interface settings	To select an interface from among RS-232C (9,600 bps), RS-232C (19,200 bps), and GP-IB. When GP-IB is selected, address (0 to 30) is to be set.	
START protection function	Makes START invalid when electricity is discharged at the end of respective tests	
TEST signal restriction	ON/OFF test signal output for external I/O while test time or while ramp-up and ramp-down time	
Evaluation output forced stop	in	Carries out test evaluation when <b>STOP</b> key is pressed after test has been forcibly terminated.
Continuous testing FAIL status	in	Test continues as long as it is within the measurement range (for withstand-voltage and insulation-resistance) even when FAIL is shown
Initial ramp-up value	Sets the initial ramp-up value (Setting range: 0.0 to 1.0, Resolution: 0.1, Minimum: 0.1 kV)	

### Other Functions

---

Contact check	<p>Makes the Contact Check function valid (no increase in tact time)</p> <p>LOW side : if no electric current is detected during checks, a result of no connection will appear</p> <p>HIGH side : upper-limit and lower-limit detection voltages used in checks can be set</p> <p>When the Contact Check measurement voltage is higher than the upper-limit value, or when it is smaller than the lower-limit value, a result of power breakage will appear</p> <p>Withstand test: voltage setting range 0.20 kV to 5.0 kV, 0.01 kV Resolution (common to both the upper and lower limits)</p> <p>Insulation-resistance measurement: 500 V; Upper Limit 600 V, Lower Limit 500 V 1000 V; Upper Limit 1200 V, Lower Limit 1000 V (Fixed in all cases)</p>
---------------	--

Accuracy of Voltmeter for Contact Check	<p>Detection method : Detection of average value and conversion to executable value</p> <p>Accuracy : <math>\pm 50</math> V</p> <p>Note: When the waveform is distorted, the error margin may become bigger.</p>
---	--

Key-lock function	Ignores key inputs when set to Key Lock
-------------------	---

Status Out	<p>Pre-set contact output in the Optional Function Screen</p> <p>Maximum input voltage: 150 V AC, 30 V DC</p> <p>Maximum contact current: 0.5 A</p> <p>Insulation method: Mechanical Contact Relay</p> <p>Output conditions</p> <ol style="list-style-type: none"> <li>1 H.V.ON</li> <li>2 TEST</li> <li>3 PASS</li> <li>4 FAIL</li> <li>5 INT.LOCK</li> <li>6 READY</li> <li>7 EXT.CONT</li> <li>8 POWER-ON</li> </ol> <p>Note: ON output for rear panel relay contact with OR for respective valid conditions</p>
------------	---



## 10.2 General Specifications

Test function	Withstand-voltage test (50 Hz/60 Hz AC), Insulation-resistance test
Test mode	Manual test mode: W/I Auto test mode: W → I, I → W
Display	Fluorescent tube display (digital display)
Monitor function	Output voltage, Detected electric current, Insulation-resistance
Monitor cycle	More than 2 times/second
Operating temperature and humidity	0°C to 40°C (32°F to 104°F), 80% RH or less (no condensation)
Storage temperature and humidity	-10°C to 50°C (14°F to 122°F), 90% RH or less (no condensation)
Temperature and humidity range for guaranteed accuracy	23±5°C (73 ±9°F), 80% RH or less (no condensation) (after 10 minutes minimum warm-up)
Period of guaranteed accuracy	1 year
Product warranty period	3 years
Operating environment	Indoors, Pollution degree 2, Up to 2000 m (6562-ft.)
Supply voltage	100 to 240 V AC (Voltage fluctuations of ±10% from the rated supply voltage are taken into account.) (Anticipated transient overvoltage 2500 V)
Supply frequency	50 Hz/60 Hz
Dielectric strength	1.62 kV AC, 50 mA, 1 minute between power supply and frame
Maximum rated power	200 VA
Dimensions	Approx. 320W x 155H x 395D mm (12.60"W x 6.10"H x 15.55"D) (not including protrusions)
Mass	Approx. 15 kg (529.1 oz.)
Accessories	Model 9615 H.V.Test Lead (high voltage side and return, 1 each) Power cord (To be designated at the time of ordering, in accordance with the powersupply voltage to be used) Instruction manual Slip Prevention Plate
Options	Model 9615 H.V.Test Lead Model 9151-02 GP-IB Connector Cable (2 m) Model 9267 Safety Test Data Management Software Model 9637 RS-232C Cable (1.8 m, 9-pin to 9-pin) Model 9638 RS-232C Cable (1.8 m, 9-pin to 25-pin) Model 9613 Remote Control Box (Single) Model 9614 Remote Control Box (Dual)
Applicable Standards	EMC EN61326 Class A Safety EN61010

## 10.3 H.V. Test Lead (Accessory) Specifications

Rated voltage	High voltage side: 5 kV AC or 5 kV DC Low voltage side : 600 V AC or 600 V DC
Rated current	High voltage side: 150 mA AC or 150 mA DC Low voltage side : 10 A AC or 10 A DC
Dielectric strength	High voltage side: 6.25 kV AC, Sensitivity current 5 mA 1 minute Low voltage side : 1.35 kV AC, Sensitivity current 5 mA 1 minute Test point (between the core wire and the cable exterior)
Operating temperature and humidity	0°C to 40°C (32°F to 104°F), 80% RH or less (no condensation)
Storage temperature and humidity	-10°C to 50°C (14°F to 122°F), 90% RH or less (no condensation)
Operating environment	Indoors, Up to 2000 m (6562-ft.)
Dimensions	Approx. 1.5 m (59.06")
Mass	Approx. 100 g (3.5 oz.) (1 each for high voltage side and return side)

# Maintenance and Service

# Chapter 11

## 11.1 Troubleshooting

### **DANGER**

To prevent electric shocks and fires, whenever the instrument is wet or dirtied by oil or dust, stop using the instrument and contact our representative for maintenance service.

### **CAUTION**

The interior of this instrument has parts which discharge high voltages and are very dangerous. Do not touch it.

Do not attempt to dismantle or repair this instrument if you are not a Hioki sales or service staff.

### **NOTE**

- If damage is suspected, check the "Troubleshooting" section before contacting your dealer or Hioki representative.
- When transporting the instrument, pack the instrument so that it will not sustain damage during shipping, and include a description of existing damage. We do not take any responsibility for damage incurred during shipping.
- The fuse is housed in the power unit of the instrument. If the power does not turn on, the fuse may be blown. If this occurs, a replacement or repair cannot be performed by customers. Please contact your dealer or Hioki representative.

### Before returning for repair

If the instrument is not functioning properly, check the following items.

Symptom	Check item and Remedy
The display does not appear when you turn the power on.	Is the power cord disconnected? → Connect the power cord. See "2.3 Connecting the Power Cord" (p. 19)
The test will not begin even if the <b>START</b> key is pressed.	Does <b>READY</b> light up? Is <b>EXT</b> turned off? → EXT I/O or Remote Control Box is given priority over the <b>START</b> key on the instrument. Turn off the power to disable the external I/O and the Remote Control Box, then turn on the power. See "Chapter 8 External Interface" (p. 103)

Symptom	Check item and Remedy
The test will not begin even if the <b>START</b> key is pressed.	Is Double Action activated in the optional function setting? → Press the <b>STOP</b> key first and then press the <b>START</b> key. <a href="#">See "6.1.3 Double Action" (p. 81)</a>
	Is the STOP signal (LOW) still sent from EXT I/O? → START signal's priority becomes lower than the STOP signal. Change the STOP signal to Hi at the START status.
	Is the <b>STOP</b> key accidentally pressed? → START signal's priority becomes lower than the STOP signal. Do not press the <b>STOP</b> key at the START status.
	Is any cable broken or poorly connected in the Contact Check Function setting? → Check the wire layout, be careful not to get an electric shock.
	Is a voltage higher than the output voltage limit value set? → Check the test voltage and output voltage limit values. Test will not start if the output voltage is set higher than the output voltage limit value. <a href="#">See "6.1.5 Output-Voltage Restricting" (p. 83)</a>
Instrument resets itself during testing or electric current measurement is unusual.	Are there any fire spark electrical discharge during testing? The instrument may not function properly due to noise caused by fire spark electrical discharge. → Insert ferrite near to the high voltage test lead side of the instrument. → Insert a current limit resistor which will not affect the tests into the input terminal (take note of the rated power and withstand-voltage of the resistor)
The measurement voltage outputting during insulation resistance tests is higher than the predetermined voltage. (Example: 570 V outputs even with 500 V setting)	Is the instrument grounded? → If not, ground the instrument. An output voltage may increase if the instrument is not grounded.

If any of the following should occur, stop using the instrument, disconnect the power cord and test lead, and contact your dealer or HIOKI representative.

- If you are certain that the instrument is damaged.
- If the measurement you wish to perform is inoperative.
- If the instrument was stored for a long period of time in high temperatures and humidity, or other undesirable conditions.
- If the instrument was damaged in transit.

## Notes on Transportation

- To ensure safe handling, when transporting the instrument, please use the original box and packing materials. However, do not use if the box is torn or out of shape, or if the packing materials are crushed.
- When packing the instrument / device / product, make sure to remove the test leads and power supply cords from the main device.
- When transporting, protect it from strong impact such as dropping it.

## 11.2 Cleaning

To clean the instrument, wipe it gently with a soft cloth moistened with water or mild detergent. Never use solvents such as benzene, alcohol, acetone, ether, ketones, thinners or gasoline, as they can deform and discolor the case.

## 11.3 Error Indication

If an error occurs, the 3174 displays the following on the screen.

Message	Description	Remedy
<b>Err0</b>	Interlock state.	See "8.3 Inter-lock Function" (p. 111)
<b>Err1</b>	External switch is unusual.	Other switches apart from the Remote Control Box (9613, 9614) are connected. If message does not go off even when standard Remote Control Box is connected, damage is possible. Contact your dealer or Hioki representative.
<b>Err2</b>	Damage due to EXT I/O is possible.	Contact your dealer or Hioki representative.
<b>Err3</b>	Damage due to <b>DANGER</b> lamp is possible.	Contact your dealer or Hioki representative.
<b>Err4</b>	Contact error at the L side terminal.	Confirm the connection to the instrument.
<b>Err5</b>	Test voltage is set lower than lower-limit voltage.	Confirm the setting.
<b>Err6</b>	Output measurement voltage is lower than the lower-limit voltage.	An output problem is possible. Check the output voltage before contacting your dealer or Hioki representative.
<b>Err7</b>	Contact voltage is lower than the lower-limit voltage.	A measurement-type problem or a contact error is possible. If the connection on the high voltage side does not present any problem, contact your dealer or Hioki representative.
<b>Err8</b>	Set voltage is set higher than the upper-limit voltage.	Confirm the setting.
<b>Err9</b>	Output voltage is higher than the upper-limit voltage.	An output-type or measurement-type problem is possible. Contact your dealer or Hioki representative.
<b>ErrH</b>	An internal part of the instrument is overheated.	Leave the instrument for several minutes without turning OFF the power switch. (Cool the instrument.) If the instrument is not restored, it may be malfunctioning. Contact your dealer or Hioki representative.

- If the displayed number is outside the test setting range, follow the instructions for "**Err3**" in the table above.
- When errors other than the above are displayed, the instrument may be malfunctioning. Contact your dealer or Hioki representative.

## 11.4 System Reset

### Contents to be reset

When the system is reset, the following will be initialized. Saved setting data will also be initialized. Optional settings will restore to the factory default values (initial settings).

The "**:SYStem:RESet**" command starts the same action.

Initial values are as follows.

\*items are items initialized with "**\*RST**" command.

Contents to be reset		Initial Values
Test mode	Test mode	Withstand-voltage mode *
Withstand-voltage mode	test-voltage	0.20 kV *
	upper-limit test value	0.2 mA *
	lower-limit test value ON/OFF	OFF *
	lower-limit test value	0.1 mA *
	test-time ON/OFF	ON *
	test-time	0.3 s *
	ramp-up timer ON/OFF	OFF *
	ramp-up timer	0.1 s *
	ramp-down time ON/OFF	OFF *
	ramp-down time	0.1 s *
	test-frequency	50 Hz *
	initial voltage for ramp-up	0.0 *
	upper-limit voltage for Contact Check ON/OFF	OFF *
	upper-limit voltage for Contact Check	0.30 kV *
	lower-limit voltage for Contact Check ON/OFF	OFF *
	lower-limit voltage for Contact Check	0.20 kV *
Insulation resistance mode	test-voltage	500 V *
	lower-limit test value	1000 M $\Omega$ *
	upper-limit test value ON/OFF	OFF *
	upper-limit test value	2000 M $\Omega$ *
	test-time ON/OFF	ON *
	test-time	0.3 s *
	delay time ON/OFF	OFF *
	delay time	0.1 s *
	upper-limit voltage for Contact Check ON/OFF	OFF *
	upper-limit voltage for Contact Check	600 V *
	lower-limit voltage for Contact Check ON/OFF	OFF *
lower-limit voltage for Contact Check	500 V *	

	Contents to be reset	Initial Values
Optional Functions	FAIL Hold, Double Action, START protection function	1 *
	Output-voltage restricting value	5.0 kV *
	PC interface	0
	GP-IB address	3
	Inter-lock	0
	Interface command "START"	0
	Others	0 *
Status Out	All	0 (Not set) *
Saved test conditions	Files in the withstand-voltage mode and insulation-resistance mode will be initialized respectively.	
Saved data	Results of the withstand-voltage test and the insulation-resistance test will be initialized.	

## Procedure for System Reset

Turn ON the main power switch while pressing the **SHIFT** key.  
Press and hold the **SHIFT** key until **READY** → **TEST** → **PASS** is shown.

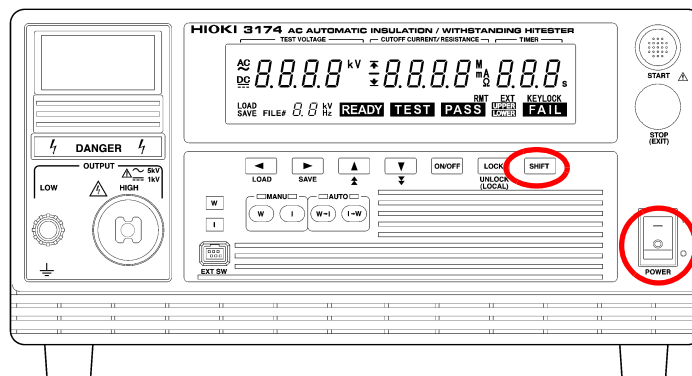



# Appendix

## Appendix1 Remote Control Box

When the Remote Control Box is connected to the instrument, test start or test stop functions can be performed without touching the instrument, thus making test administrations safer.



- To avoid electric shock, check the following before connecting the Remote Control Box.

(1) The power switch is turned off.

(2) The **DANGER** lamp is OFF.

To avoid electric shock, provide safety measures to keep the output-voltage terminal, test lead, and tested object out of contact with one another when the **TEST** lamp is lit.



To prevent mishandling, do not remove the Remote Control Box after switching on the instrument. When removing the Remote Control Box, be sure to switch off the power first.

### Connecting the Remote Control Box

Front panel

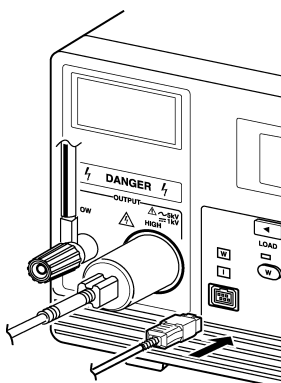
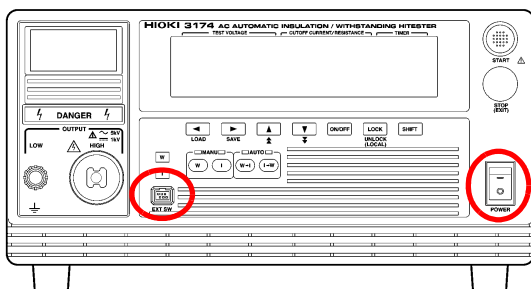

1. Make sure the power switch and **OPERATE** switch on the Remote Control Box are OFF.
2. Connect the Remote Control Box plug to the remote control connection terminal on the instrument.
3. Turn ON the operate switch of the Remote Control Box. The **OPERATE** switch can be turned ON/OFF even following startup.

# A2

## Appendix1 Remote Control Box

### The 9613 Remote Control Box (Single)

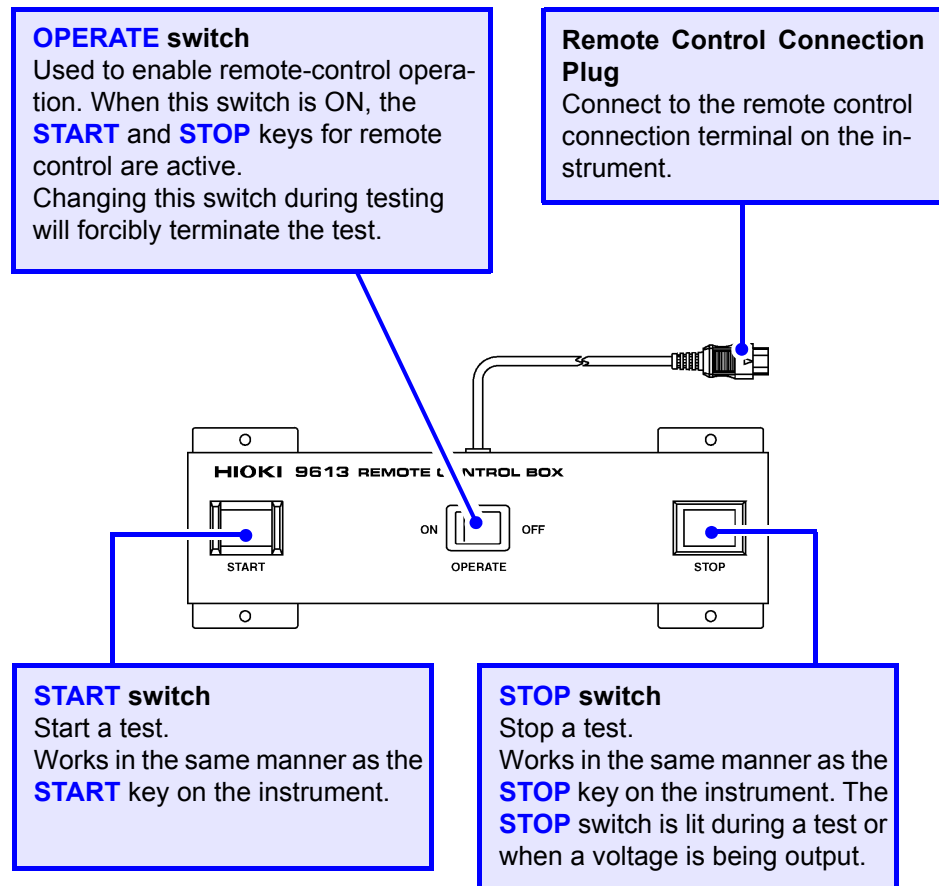

### Specifications

Operating temperature and humidity	0°C to 40°C (32°F to 104°F), 80% RH or less (no condensation)
Storage temperature and humidity	-10°C to 50°C (14°F to 122°F), 90% RH or less (no condensation)
Operating environment	Indoors, Up to 2000 m (6562-ft.)
Dimensions	Approx. 193W x 50H x 30D mm (7.60"W x 1.97"H x 1.18"D) (not including protrusions)
Mass	Approx. 500 g (17.6 oz.)
Cord length	Approx. 1.5 m (59.06")

The 9614 Remote Control Box (Dual)

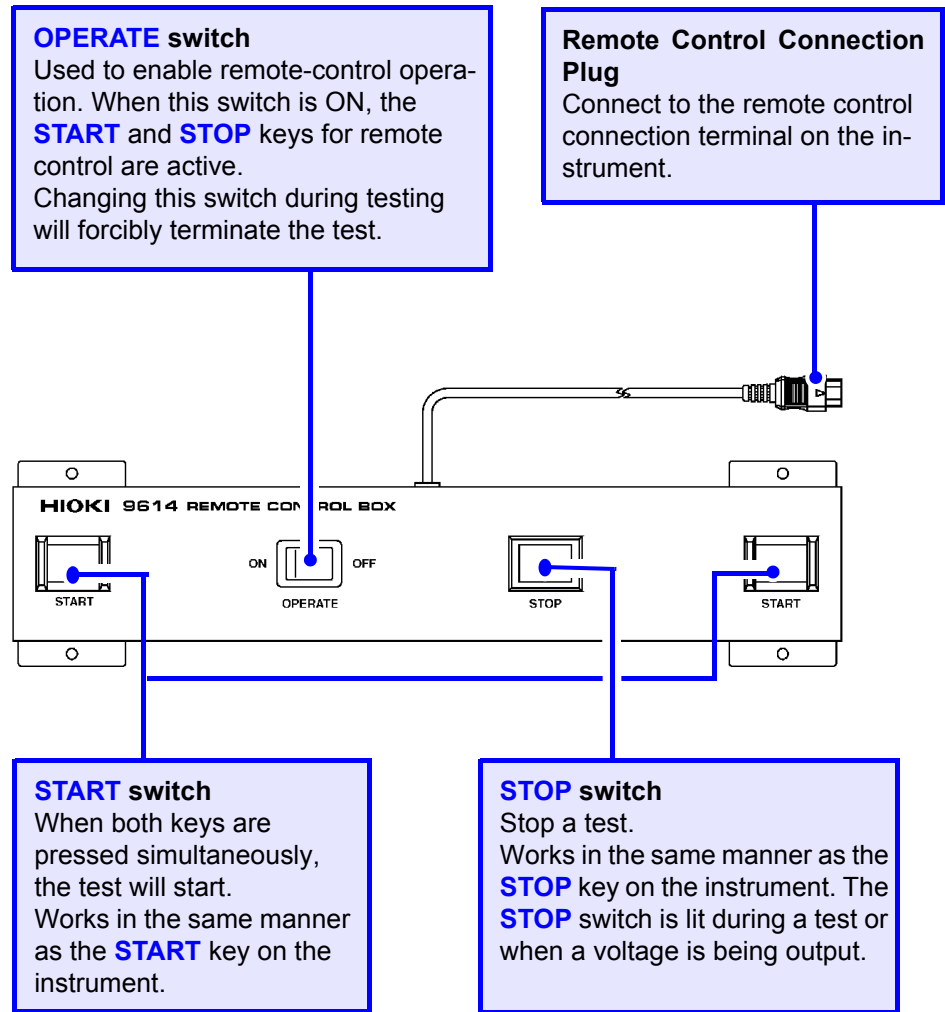

Specifications

Operating temperature and humidity	0°C to 40°C (32°F to 104°F), 80% RH or less (no condensation)
Storage temperature and humidity	-10°C to 50°C (14°F to 122°F), 90% RH or less (no condensation)
Operating environment	Indoors, Up to 2000 m (6562-ft.)
Dimensions	Approx. 270W x 50H x 30D mm (10.63"W x 1.97"H x 1.18"D) (not including protrusions)
Mass	Approx. 700 g (24.7 oz.)
Cord length	Approx. 1.5 m (59.06")

The 9614 Remote Control Box (Dual) comes with two **START** switches which must both be pressed before the test can start, thus making it a safer way to conduct a test. Combine with the Momentary Out Optional Function for better safety. See "6.1.2 Momentary Out" (p. 80)

# Appendix2 List of Optional Functions

Setting the optional functions allows testing under various conditions. To set an optional function, select the number assigned to the function (except for output-voltage setting).

## Setting optional functions

1. (**READY** is lit) Make sure the **READY** lamp is lit on the screen.

\* **READY** will not be displayed during the Double Action setting.

2. Press the **STOP** key while holding down the **SHIFT** key to display the optional screen (page 1).

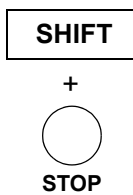

Output-voltage  
restricting value

Page No.

3. Press the **▶** key to move the flashing cursor to the position of required function.



<Ex.> Select FAIL hold

To set pages 2 to 3, move the flashing cursor to the position of the page number, and change the page with the **▲** / **▼** keys.

4. Select a setting with the **▲** / **▼** keys.

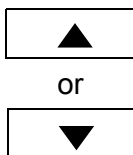

<Ex.> Select No FAIL hold.

5. Press the **STOP** key while holding down the **SHIFT** key to complete the setting value.

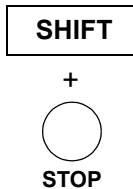

The instrument reverts to the READY state.

To continue to the setting for the next item, press the **▶** key.

Optional Screen (page 1)

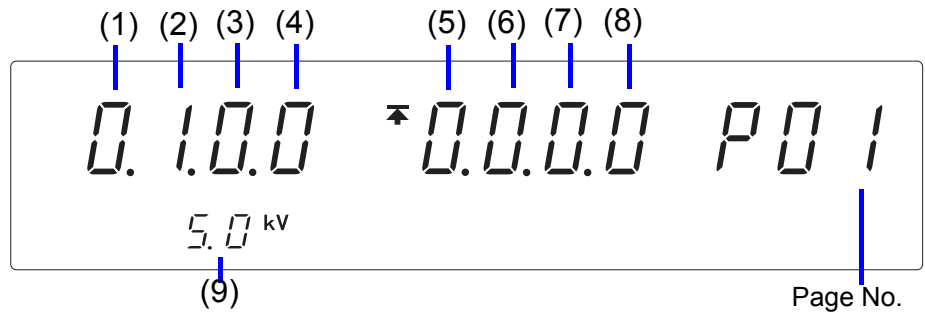

(1) Pass hold function	This status will be retained in a PASS status. Use this setting to confirm test evaluations and evaluation values. 0: OFF (Initial setting) 1: ON
(2) Fail hold function	This status will be retained in a FAIL status. Use this setting to confirm test evaluations and evaluation values. 0: OFF 1: ON (Initial setting)
(3) STOP hold function	Retains the value when the test has been forcibly terminated by pressing the <b>STOP</b> key during the test. 0: OFF (Initial setting) 1: ON
(4) Momentary output	The momentary out function allows voltage output only while the <b>START</b> key is held down. The <b>START</b> key on the remote control or the START signal via external I/O has the same effect. 0: OFF (Initial setting) 1: ON
(5) Double action	Enable this function to allow testing to start only when the <b>START</b> key is pressed within about 0.5 seconds after the <b>STOP</b> key. 0: OFF 1: ON (Initial setting)
(6) Fail mode	Enable this function to restrict hold release to the <b>STOP</b> key on the main instrument. 0: OFF (Initial setting) 1: ON
(7) Interface command "START"	Used to make interface command "START" valid or non-valid. 0: Start command invalid (Initial setting), changing the voltage supplied using keys not possible 1: Start command valid, changing the voltage supplied using keys not possible 2: Start command invalid, changing the voltage supplied using keys possible 3: Start command valid, changing the voltage supplied using keys possible
(8) Inter-lock function	Enable this function to activate the external I/O interlock terminals. 0: OFF (Initial setting) 1: ON
(9) Output-voltage restricting value	Enable this function to set the upper-limit value for the output voltage (Withstand-voltage test only). 0.2 to 5.0 kV (Can be set in 0.1-kV steps) (Initial setting: 5.0 kV)

## Optional Screen (page 2)

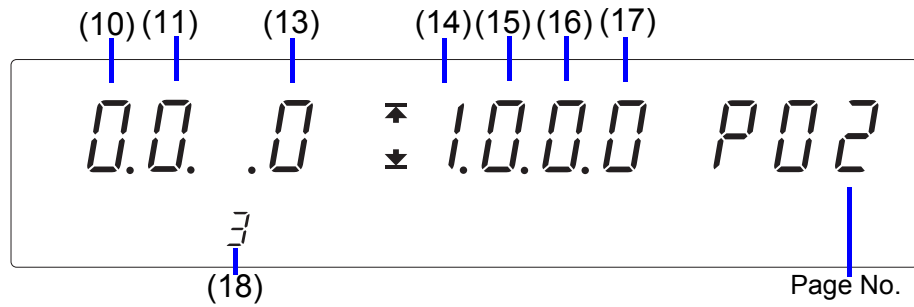

<p>(10) Insulation-resistance test measurement range</p>	<p>Select whether you want to use a fixed or an automatic range as the insulation-resistance test measurement range. The fixed ranges are automatically selected depending on the preset lower-limit value. Auto range switches between ranges depending on the measured value, but it takes time to display this value, since it is displayed after the range is switched. (This takes approximately 1.3 seconds.)  <b>0:</b> Fixed range (Initial setting)  <b>1:</b> Auto range</p>
<p>(11) Insulation-resistance test termination mode</p>	<p>When performing an insulation-resistance test, set whether you want to conduct the test for the set test time regardless of the decision, terminate the test when PASS screening is performed, or terminate the test when FAIL screening is performed. This mode is effective when the test time is set.  <b>0:</b> Test for set time (Initial setting)  <b>1:</b> Terminate test at PASS screening  <b>2:</b> Terminate test at FAIL screening</p>
<p>(13) PC interface</p>	<p>Enable this function to select a PC interface to be used. When GP-IB is selected, set the GP-IB address.  <b>0:</b> RS-232C (9600 bps) (Initial setting)  <b>1:</b> RS-232C (19200 bps)  <b>2:</b> GP-IB</p>
<p>(14) START protection function</p>	<p>Select whether START is to be invalid during the discharge time upon completion of each test.  <b>0:</b> OFF  <b>1:</b> ON (Initial setting)</p>
<p>(15) TEST-signal output</p>	<p>Set the external I/O TEST signal output period.  <b>0:</b> TEST signal ON, while all test time including ramp-up and ramp-down time (Initial setting)  <b>1:</b> TEST signal ON, while set test time  <b>2:</b> TEST signal ON, only while ramp-up and ramp-down time</p>
<p>(16) Evaluation output in a forced termination</p>	<p>Determines whether to evaluate the test or not when the test is forcibly terminated by the STOP key.  <b>0:</b> No evaluation in a forced termination (Initial setting)  <b>1:</b> Evaluate even in a forced termination</p>
<p>(17) Test Continuation status</p>	<p>Determines whether to continue testing or not when the evaluation is FAIL.  <b>0:</b> Stop the test when evaluation is FAIL (Initial setting)  <b>1:</b> Continue the test with FAIL evaluation</p>
<p>(18) GP-IB address</p>	<p>Sets address to be used when GP-IB is chosen in the PC interface.            GP-IB address: 0 to 30 (Initial setting: 3)</p>

Optional Screen (page 3)

See "6.9 Status Out" (p. 96)

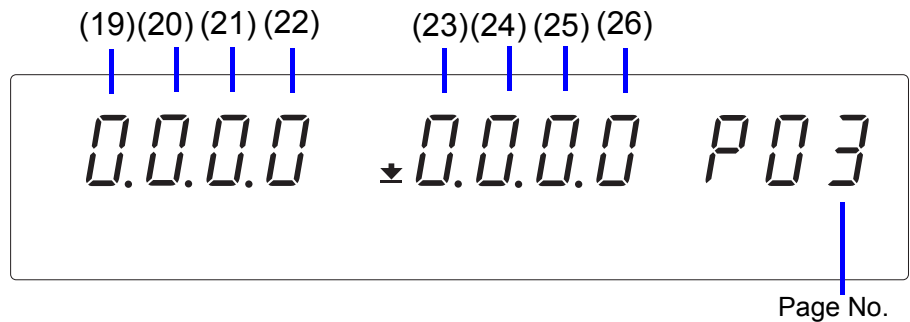

(19) H.V.ON	High voltage supply 0: OFF (Initial setting) 1: ON
(20) TEST	Test in progress 0: OFF (Initial setting) 1: ON
(21) PASS	PASS state 0: OFF (Initial setting) 1: ON
(22) FAIL	FAIL state 0: OFF (Initial setting) 1: ON
(23) INT.LOCK	Interlock state 0: OFF (Initial setting) 1: ON
(24) READY	READY state 0: OFF (Initial setting) 1: ON
(25) EXT.CONT	When controlled externally. ("EXT" lights up on the screen) 0: OFF (Initial setting) 1: ON
(26) POWER-ON	When the power is switched on. 0: OFF (Initial setting) 1: ON

# A8

## Appendix2 List of Optional Functions

---

### Example of a setting for optional functions

The following describes how 3174 optional functions are used for testing. Various combinations of optional functions are possible for testing.

<Ex. 1>

To confirm the test results



PASS Hold Function : 1 (ON)

FAIL Hold Function : 1 (ON)

PASS or FAIL state is held, allowing inspection of test results.

<Ex. 2>

Safe testing by remote control

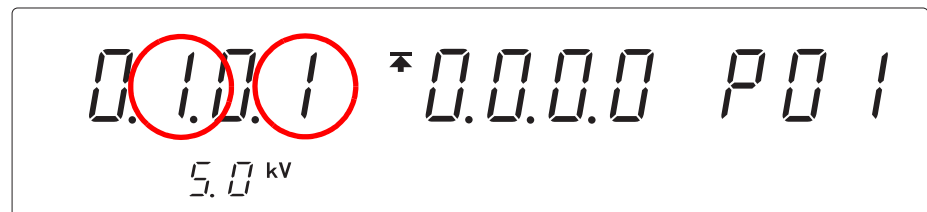

FAIL Hold Function : 1 (ON)

Momentary Out : 1 (ON)

Hold down the **START** key during the test, as the Momentary-Out function is set. The 9614 Remote Control Box (Dual) must be operated with both hands during the test. This prevents high-voltage devices such as the probe and tested object from coming into contact with the hands.

The FAIL Hold function must be cancelled using the **STOP** key on the instrument, as the FAIL Hold is set. The use of the FAIL mode enables the FAIL state to be set.



# Index

## Numerics

9613 Remote Control Box (Single) .....	A2
9614 Remote Control Box (Dual) .....	A3
9615 H.V. Test Lead .....	13

## A

Automatic Discharge Function	
Automatic Test .....	74
Insulation-Resistance Test .....	60
Automatic Test .....	69
Auto-range .....	95

## B

Breaking Current .....	26
Buzzer Adjustment Knob .....	11
Buzzer Sound .....	119

## C

Changing the Output Voltage .....	91
Character Data .....	131
Command	
Common Commands (GP-IB only) .....	142
Common Commands (RS-232C/ GP-IB) .....	139
Reference List .....	139
Specific Commands (GP-IB only) .....	142
Specific Commands (RS-232C only) .....	142
Specific Commands (RS-232C/ GP-IB) .....	139
Command Message .....	129
Command Messages .....	129
Command Syntax .....	129
Confirmation Voltage used for upper and lower-limits for Contact Check	
Insulation-Resistance Test .....	55
Withstand-Voltage Test .....	38
Connection Terminal for Remote Control Box .....	9
Connector .....	124
Connector Pin Numbering .....	104
Contact Check Function .....	21, 27
Continuous Test Mode .....	89
CR .....	130
CR+LF .....	130
Crossover cable .....	125

## D

DANGER Lamp .....	9
Data Formats .....	131
Decimal Numeric Data .....	131
Delay Time .....	54
Device Clear .....	132
Display .....	12
Display Hold .....	84
Double Action .....	81

## E

EOI .....	130
Error Indication .....	200
Event Status Register	
Device-Specific .....	136
Standard .....	135
EXT I/O Connector .....	11, 106
External Dimensions .....	14
External I/O .....	103
External Interface .....	103

## F

FAIL Determination	
Automatic Test .....	78
Insulation-Resistance Test .....	63
Withstand-Voltage Test .....	46
FAIL Hold .....	86, 90
FAIL Mode .....	90
Fixed-Point Data .....	131
Floating-Point Exponential Representation Data .....	131
Forcibly Terminate	
Automatic Test .....	73
Insulation-Resistance Test .....	59
Withstand-Voltage Test .....	42

## G

GP-IB .....	121, 126
GP-IB Address .....	127
GP-IB Connector .....	11, 125

## H

Headers .....	130
HIGH Contact Check Terminal .....	11
HIGH Voltage Output Terminal .....	9, 11
Hold Function .....	84

**Index**

<b>I</b>	
IEEE 488.2 .....	131
Initial Voltage for Ramp-up .....	37
Initialization Items .....	138
Input Buffer .....	132
Instrument Installation .....	4
Insulation-Resistance Test .....	47
Insulation-Resistance Test Termination Mode ...	92
Integer Data .....	131
Interface Command "START" .....	188
Inter-lock .....	27, 111
<b>K</b>	
Key-lock Function .....	79
<b>L</b>	
LF .....	130
Loading the Test Conditions .....	102
Local .....	137, 138
LOW Contact Check Terminal .....	11
LOW Voltage Output Terminal .....	9, 11
Lower Limit Value	
Insulation-Resistance Test .....	51
Withstand-Voltage Test .....	33
<b>M</b>	
Measured Resistance .....	27
Measurement Ranges .....	52
Memory Selection Terminal .....	114
Message Reference .....	143
Message Terminators .....	130
Momentary Out .....	80
<b>N</b>	
NR1 .....	131
NR2 .....	131
NR3 .....	131
NRf .....	131
<b>O</b>	
Operation Keys .....	10
Optional Functions .....	A4
Output Queue .....	132
Output-Voltage Restricting .....	83
<b>P</b>	
PASS Determination	
Automatic Test .....	76
Insulation-Resistance Test .....	62
Withstand-Voltage Test .....	45
PASS Hold .....	85
Power .....	24
Power Cord .....	19
Power Inlet .....	19
Pre-test Check .....	26
Program Messages .....	129
Protective Conductor Terminal .....	11, 18
<b>Q</b>	
Query Error .....	132
Query Message .....	129
<b>R</b>	
Ramp-down Time Timer .....	35
Ramp-up Time Timer .....	35
Remote .....	137, 138
Remote Control Box .....	A1
Response Messages .....	129
RS-232C .....	121, 126
RS-232C Connector .....	11, 124
<b>S</b>	
Sample Program .....	184
Saving the Test Conditions .....	99
Separators .....	131
Signal Line .....	104
Specifications .....	189
START Protection .....	82
Status Byte Register .....	133
Status Out .....	96
STATUS OUT relay terminal .....	97
Status Out Relay Terminal .....	11
STOP Hold .....	87
System Reset .....	201
<b>T</b>	
Terminators .....	130
Test Lead .....	20
Test Time Timer	
Insulation-Resistance Test .....	53
Withstand-Voltage Test .....	34
Test-Frequency .....	36
Testing Process .....	15
TEST-Signal Output .....	113
Test-Voltage Value	
Insulation-Resistance Test .....	50
Withstand-Voltage Test .....	32
Timing Chart .....	115
Transmission and Response Formats .....	183

**U**

---

Upper Limit Value	
Insulation-Resistance Test .....	51
Withstand-Voltage Test .....	33

**W**

---

Withstand-Voltage Test .....	29
------------------------------	----



# Warranty Certificate

# HIOKI

Model	Serial number	Warranty period Three (3) years from date of purchase ( ___ / ___ )
-------	---------------	--

Customer name: \_\_\_\_\_

Customer address: \_\_\_\_\_

## Important

- Please retain this warranty certificate. Duplicates cannot be reissued.
- Complete the certificate with the model number, serial number, and date of purchase, along with your name and address. The personal information you provide on this form will only be used to provide repair service and information about Hioki products and services.

This document certifies that the product has been inspected and verified to conform to Hioki's standards. Please contact the place of purchase in the event of a malfunction and provide this document, in which case Hioki will repair or replace the product subject to the warranty terms described below.

## Warranty terms

1. The product is guaranteed to operate properly during the warranty period (three [3] years from the date of purchase). If the date of purchase is unknown, the warranty period is defined as three (3) years from the date (month and year) of manufacture (as indicated by the first four digits of the serial number in YYMM format).
2. If the product came with an AC adapter, the adapter is warranted for one (1) year from the date of purchase.
3. The accuracy of measured values and other data generated by the product is guaranteed as described in the product specifications.
4. In the event that the product or AC adapter malfunctions during its respective warranty period due to a defect of workmanship or materials, Hioki will repair or replace the product or AC adapter free of charge.
5. The following malfunctions and issues are not covered by the warranty and as such are not subject to free repair or replacement:
  - 1. Malfunctions or damage of consumables, parts with a defined service life, etc.
  - 2. Malfunctions or damage of connectors, cables, etc.
  - 3. Malfunctions or damage caused by shipment, dropping, relocation, etc., after purchase of the product
  - 4. Malfunctions or damage caused by inappropriate handling that violates information found in the instruction manual or on precautionary labeling on the product itself
  - 5. Malfunctions or damage caused by a failure to perform maintenance or inspections as required by law or recommended in the instruction manual
  - 6. Malfunctions or damage caused by fire, storms or flooding, earthquakes, lightning, power anomalies (involving voltage, frequency, etc.), war or unrest, contamination with radiation, or other acts of God
  - 7. Damage that is limited to the product's appearance (cosmetic blemishes, deformation of enclosure shape, fading of color, etc.)
  - 8. Other malfunctions or damage for which Hioki is not responsible
6. The warranty will be considered invalidated in the following circumstances, in which case Hioki will be unable to perform service such as repair or calibration:
  - 1. If the product has been repaired or modified by a company, entity, or individual other than Hioki
  - 2. If the product has been embedded in another piece of equipment for use in a special application (aerospace, nuclear power, medical use, vehicle control, etc.) without Hioki's having received prior notice
7. If you experience a loss caused by use of the product and Hioki determines that it is responsible for the underlying issue, Hioki will provide compensation in an amount not to exceed the purchase price, with the following exceptions:
  - 1. Secondary damage arising from damage to a measured device or component that was caused by use of the product
  - 2. Damage arising from measurement results provided by the product
  - 3. Damage to a device other than the product that was sustained when connecting the device to the product (including via network connections)
8. Hioki reserves the right to decline to perform repair, calibration, or other service for products for which a certain amount of time has passed since their manufacture, products whose parts have been discontinued, and products that cannot be repaired due to unforeseen circumstances.

**HIOKI E.E. CORPORATION**

<http://www.hioki.com>

18-07 EN-3





# HIOKI

<http://www.hioki.com>



**Our regional  
contact  
information**

**HEADQUARTERS**

81 Koizumi  
Ueda, Nagano 386-1192 Japan

**HIOKI EUROPE GmbH**

Rudolf-Diesel-Strasse 5  
65760 Eschborn, Germany  
[hioki@hioki.eu](mailto:hioki@hioki.eu)

1808EN

Edited and published by HIOKI E.E. CORPORATION

Printed in Japan

- CE declarations of conformity can be downloaded from our website.
- Contents subject to change without notice.
- This document contains copyrighted content.
- It is prohibited to copy, reproduce, or modify the content of this document without permission.
- Company names, product names, etc. mentioned in this document are trademarks or registered trademarks of their respective companies.